

## 1.22 Concentration of Solutions

A solution is a mixture formed when a solute dissolves in a solvent. In chemistry we most commonly use water as the solvent to form aqueous solutions. The solute can be a solid, liquid or a gas.

Molar concentration can be measured for solutions. This is calculated by dividing the amount in moles of the solute by the volume of the solution. The volume is measured in  $\text{dm}^3$ . The unit of molar concentration is  $\text{mol dm}^{-3}$ ; it can also be called molar using symbol M

$$\text{Concentration} = \frac{\text{amount}}{\text{volume}}$$

Unit of concentration:  $\text{mol dm}^{-3}$  or M

Unit of Volume:  $\text{dm}^3$

### Converting volumes

A  $\text{m}^3$  is equivalent to a cube  
 $100\text{cm} \times 100\text{cm} \times 100\text{cm} = 1000000\text{cm}^3$

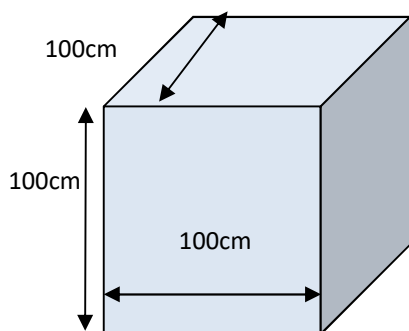

$1\text{m}^3$

$$1\text{m}^3 = 1000\text{dm}^3 \text{ or } 1000\text{L}$$

To convert  $\text{m}^3$  into  $\text{dm}^3$  multiply by 1000

A  $\text{dm}^3$  is equivalent to a cube  
 $10\text{cm} \times 10\text{cm} \times 10\text{cm} = 1000\text{cm}^3$

$$1\text{dm}^3 = 1\text{litre}$$

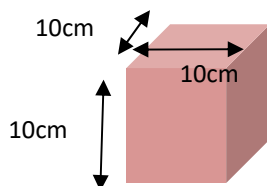

$1\text{dm}^3$  or 1 litre

$$1\text{dm}^3 = 1000\text{cm}^3 \text{ or } 1000\text{mL}$$

To convert  $\text{cm}^3$  into  $\text{dm}^3$  divide by 1000

A  $\text{cm}^3$  is equivalent to a cube  
 $1\text{cm} \times 1\text{cm} \times 1\text{cm}$

$$1\text{cm}^3 = 1\text{ml}$$

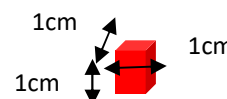

$1\text{cm}^3$

$$\text{cm}^3 \rightarrow \text{dm}^3 \div 1000$$

$$\text{cm}^3 \rightarrow \text{m}^3 \div 1000000$$

$$\text{dm}^3 \rightarrow \text{m}^3 \div 1000$$

**Example 1** What is the concentration of solution made by dissolving 5.00g of  $\text{Na}_2\text{CO}_3$  in  $250\text{cm}^3$  water?

$$\text{amount} = \frac{\text{mass}}{M_r}$$

$$= \frac{5}{(23.0 \times 2 + 12 + 16 \times 3)}$$

$$= 0.0472\text{ mol}$$

$$\text{conc} = \frac{\text{amount}}{\text{Volume}}$$

$$= \frac{0.0472}{0.25}$$

$$= 0.189\text{ mol dm}^{-3}$$

**Example 2** What is the concentration of solution made by dissolving 10kg of  $\text{Na}_2\text{CO}_3$  in  $0.50\text{m}^3$  water?

$$\text{amount} = \frac{\text{mass}}{M_r}$$

$$= \frac{10000}{(23.0 \times 2 + 12 + 16 \times 3)}$$

$$= 94.2\text{ mol}$$

$$\text{conc} = \frac{\text{amount}}{\text{Volume}}$$

$$= \frac{94.2}{500}$$

$$= 0.19\text{ mol dm}^{-3}$$

## Mass Concentration

The concentration of a solution can also be measured in terms of mass of solute per volume of solution

$$\text{Mass Concentration} = \frac{\text{mass}}{\text{volume}}$$

Unit of mass concentration:  $\text{g dm}^{-3}$

Unit of Mass **g**

Unit of Volume:  **$\text{dm}^3$**

To turn concentration measured in  $\text{mol dm}^{-3}$  into concentration measured in  $\text{g dm}^{-3}$  multiply by *Mr* of the substance

$$\text{conc in g dm}^{-3} = \text{conc in mol dm}^{-3} \times Mr$$

The concentration in  $\text{g dm}^{-3}$  is the same as the mass of solute dissolved in  $1\text{dm}^3$

## Ions dissociating

When soluble ionic solids dissolve in water they will dissociate into separate ions. This can lead to the concentration of ions differing from the concentration of the solute.

If 5.86g (0.1 mol) of sodium chloride (NaCl) is dissolved in  $1\text{ dm}^3$  of water then the concentration of sodium chloride solution would be  $0.1\text{ mol dm}^{-3}$ .

However the 0.1mol sodium chloride would split up to form 0.1 mol of sodium ions and 0.1 mol of chloride ions. The concentration of sodium ions is therefore  $0.1\text{ mol dm}^{-3}$  and the concentration of chloride ions is also  $0.1\text{ mol dm}^{-3}$

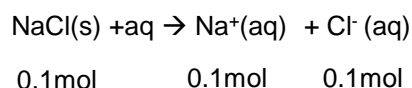

If 9.53g (0.1 mol) of magnesium chloride ( $\text{MgCl}_2$ ) is dissolved in  $1\text{ dm}^3$  of water then the concentration of magnesium chloride solution ( $\text{MgCl}_2\text{ aq}$ ) would be  $0.1\text{ mol dm}^{-3}$ .

However the 0.1mol magnesium chloride would split up to form 0.1 mol of magnesium ions and 0.2 mol of chloride ions. The concentration of magnesium ions is therefore  $0.1\text{ mol dm}^{-3}$  and the concentration of chloride ions is now  $0.2\text{ mol dm}^{-3}$

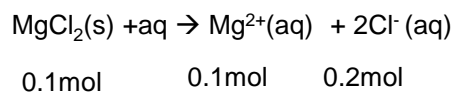

## Questions

- 1.1) If 25.0g of potassium nitrate ( $\text{KNO}_3$ ) was dissolved in  $750\text{cm}^3$  of water, what would be the molar concentration?
- 1.2) Calculate the concentration in  $\text{mol dm}^{-3}$  of 3.78 g of potassium iodide (KI) in  $35\text{ cm}^3$  of solution
- 1.3) Calculate the concentration in  $\text{mol dm}^{-3}$  of 5.10 kg of sodium bromide in  $0.250\text{ m}^3$  of solution
- 1.4) What mass of  $\text{Na}_2\text{CO}_3$  would be needed to make  $500\text{cm}^3$  of  $0.250\text{ mol dm}^{-3}$  solution?
- 1.5) If 8.20 g of  $\text{CaCl}_2$  was dissolved in  $50\text{cm}^3$  of water, what would be the concentration of chloride ions in  $\text{mol dm}^{-3}$ ?
- 1.6) a) Calculate the mass of Borax Crystals  $\text{Na}_2\text{B}_4\text{O}_7 \cdot 10\text{H}_2\text{O}$  needed to make up  $250\text{cm}^3$  of  $0.100\text{ mol dm}^{-3}$  solution?  
b) What would the mass concentration of this solution be in  $\text{g dm}^{-3}$ ?
- 1.7) What mass of hydrated magnesium chloride ( $\text{MgCl}_2 \cdot 6\text{H}_2\text{O}$ ) would be needed to make up  $500\text{ cm}^3$  of a solution of  $0.100\text{ mol dm}^{-3}$  of chloride ions
- 1.8) For drivers in the UK, the legal limit of the concentration of ethanol (molar mass  $46.0\text{ g mol}^{-1}$ ) in the blood is  $80.0\text{ mg per }100\text{ cm}^3$ . What is this equivalent to in concentration measured in  $\text{mol dm}^{-3}$ ?
- 1.9) How many moles of **ions** are present in  $30\text{ cm}^3$  of  $0.050\text{ mol dm}^{-3}$  calcium chloride solution,  $\text{CaCl}_2(\text{aq})$
- 1.10) The concentration of blood glucose can be given in millimoles per  $\text{dm}^3$  or  $\text{mmol dm}^{-3}$ .  $5.0\text{ mmol dm}^{-3}$  is a normal value of the concentration. Glucose has a molar mass of  $180\text{ g mol}^{-1}$ . What mass of glucose dissolved in  $1\text{ dm}^3$  of blood would give this normal reading?
- 1.11) A saturated aqueous solution of magnesium hydroxide contains  $1.17\text{ mg}$  of  $\text{Mg}(\text{OH})_2$  in  $100\text{ cm}^3$  of solution. Assume the magnesium hydroxide is fully dissociated into ions. What would be the concentration of magnesium ions in  $\text{mol dm}^{-3}$ ?

## Making a solution

- Weigh the sample bottle containing the required mass of solid on a 2 dp balance
- Transfer to beaker and reweigh sample bottle
- Record the difference in mass
  
- Add 100cm<sup>3</sup> of distilled water to the beaker. Use a glass rod to stir to help dissolve the solid.
  
- Sometimes the substance may not dissolve well in cold water so the beaker and its contents could be heated gently until all the solid had dissolved.
  
- Pour solution into a 250cm<sup>3</sup> graduated flask via a funnel.
- Rinse beaker and funnel and add washings from the beaker and glass rod to the volumetric flask.
- make up to the mark with distilled water using a dropping pipette for last few drops.
- Invert flask several times to ensure uniform solution.



Graduated/volumetric flask

Alternatively the known mass of solid in the weighing bottle could be transferred to beaker, washed and washings added to the beaker.

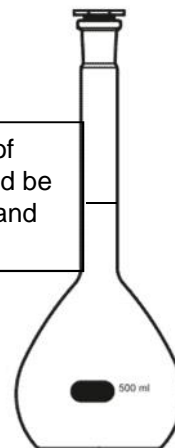

Remember to fill so the bottom of the meniscus sits on the line on the neck of the flask. With dark liquids like potassium manganate it can be difficult to see the meniscus.

Shake the volumetric flask thoroughly to ensure a uniform concentration

A graduated flask has one mark on the neck which the level to fill to get the accurate volume. Do not heat or put hot solutions in the volumetric flask because the heat would cause the flask to expand and the volume would then be incorrect.

## Dilutions

### Diluting a solution

- Pipette 25 cm<sup>3</sup> of original solution into volumetric flask
- make up to the mark with distilled water using a dropping pipette for last few drops.
- Invert flask several times to ensure uniform solution.

Using a volumetric pipette is more accurate than a measuring cylinder because it has a smaller sensitivity error

Use a teat pipette to make up to the mark in volumetric flask to ensure volume of solution accurately measured and one doesn't go over the line

### Calculating Dilutions

Diluting a solution will not change the amount of moles of solute present but increase the volume of solution and hence the concentration will lower

Amount = volume X concentration

If amount of moles does not change then

Original volume x original concentration = new diluted volume x new diluted concentration

so

$$\text{new diluted concentration} = \text{original concentration} \times \frac{\text{Original volume}}{\text{new diluted volume}}$$

The new diluted volume will be equal to the original volume of solution added + the volume of water added.

#### Example

If 50 cm<sup>3</sup> of water are added to 150 cm<sup>3</sup> of a 0.20 mol dm<sup>-3</sup> NaOH solution, what will the concentration of the diluted solution be?

new diluted concentration = original concentration x  $\frac{\text{Original volume}}{\text{new diluted volume}}$

$$\begin{aligned} \text{new diluted concentration} &= 0.20 \times \frac{0.150}{0.200} \\ &= 0.15 \text{ mol dm}^{-3} \end{aligned}$$

#### Questions

2.1) If 90.0 cm<sup>3</sup> of water are added to 50.0 cm<sup>3</sup> of a 1.00 mol dm<sup>-3</sup> HNO<sub>3</sub> solution, what will the concentration of the diluted solution be?

2.2) How much water would need to be added to 100 cm<sup>3</sup> of a 0.15 mol dm<sup>-3</sup> NaOH solution to dilute it to a concentration of 0.05 mol dm<sup>-3</sup>?

2.3) What volume of 0.1 mol dm<sup>-3</sup> NaCl solution can be made by adding water to dilute 50 cm<sup>3</sup> of 10 mol dm<sup>-3</sup> NaCl?

2.4) How much water would need to be added to dilute 25.0 cm<sup>3</sup> of a 12.0 mol dm<sup>-3</sup> HCl solution to make a 0.500 mol dm<sup>-3</sup> HCl solution?

2.5) A student is provided with a 5.00 cm<sup>3</sup> sample of 1.00 × 10<sup>-2</sup> mol dm<sup>-3</sup> hydrochloric acid. The student is asked to prepare a hydrochloric acid solution with a concentration of 5.00 × 10<sup>-4</sup> mol dm<sup>-3</sup> by diluting the sample with water. How much water should they add?

## Concentrations of mixtures

### Adding a solid to a solution

If a second solid solute is added to an existing solution of a different solute then the new mixture will have a concentration for both solutes. If the two solutes do not react with each other then there will be no change in the amount of moles of either solute.



0.3 mol of  
solid NaCl

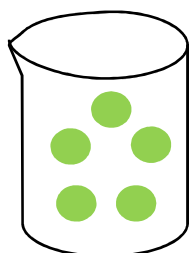

0.5 mol of KCl dissolved in  
 $100\text{cm}^3$  of water  
:concentration  $0.05\text{ mol dm}^{-3}$

Add the  
solid NaCl  
to the KCl  
solution

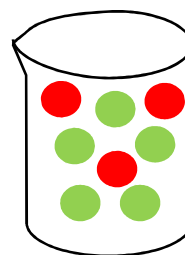

Now have 0.3 mol of NaCl and 0.5 mol  
of KCl dissolved in  $100\text{cm}^3$  of water

In the mixture the concentration of NaCl is  
 $0.03\text{ mol dm}^{-3}$  and the concentration of KCl is  
 $0.05\text{ mol dm}^{-3}$ . Note the concentration of KCl  
has not changed

### Adding two different solutions together

If a second solution is added to an existing solution of a different solute then the new mixture will have a concentration for both solutes. If the two solutions do not react with each other then there will be no change in the amount of moles of either solute.

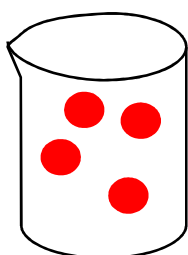

0.4 mol of NaCl  
dissolved in  $100\text{cm}^3$   
of water  
:concentration  $0.04\text{ mol dm}^{-3}$

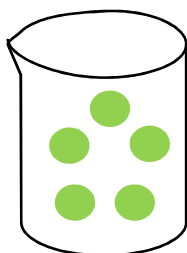

0.5 mol of KCl  
dissolved in  $100\text{cm}^3$   
of water  
:concentration  $0.05\text{ mol dm}^{-3}$

Add the  
solution of  
NaCl to the KCl  
solution

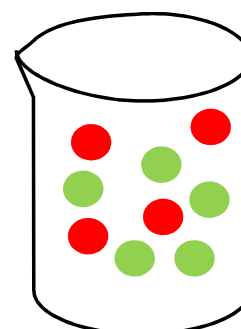

Now have 0.4 mol of NaCl and 0.5 mol  
of KCl dissolved in  $200\text{cm}^3$  of water

In the mixture the concentration of NaCl is  
 $0.02\text{ mol dm}^{-3}$  and the concentration of KCl  
is  $0.025\text{ mol dm}^{-3}$ . Note the concentration of  
both solutions have halved

### Questions

- 3.1) If 5.0g of Sodium chloride is added to  $250\text{cm}^3$  of a solution of  $0.10\text{ mol dm}^{-3}$  HCl, what will be the concentrations of NaCl and HCl after they are added together?
- 3.2) If  $50\text{cm}^3$  of  $0.10\text{ mol dm}^{-3}$  potassium chloride solution is added to  $150\text{cm}^3$  of  $0.15\text{ mol dm}^{-3}$  HCl, what will be the concentrations of KCl and HCl after they are added together?
- 3.3) A student has a  $0.10\text{ mol dm}^{-3}$  solution of NaCl and a  $0.20\text{ mol dm}^{-3}$  solution of KCl. The student wants to make a mixture of the two solutions where the NaCl has a concentration of  $0.075\text{ mol dm}^{-3}$  and the KCl has a concentration of  $0.050\text{ mol dm}^{-3}$  when mixed together. What ratio of volume of NaCl to volume of KCl would make the new concentrations?

## Density

Density is used in chemistry for pure substances rather than mixtures. Most commonly we would use it work out the mass of a known volume of a pure organic liquid such as ethanol, and then we would often convert the mass into amount in moles.

$$\text{density} = \frac{\text{mass}}{\text{Volume}}$$

Density is usually given in  $\text{g cm}^{-3}$   
Care needs to be taken if different units are used.

**Example** : How many molecules of ethanol are there in a  $0.500 \text{ dm}^3$  of ethanol ( $\text{CH}_3\text{CH}_2\text{OH}$ ) liquid ? The density of ethanol is  $0.789 \text{ g cm}^{-3}$

$$\begin{aligned}\text{Mass} &= \text{density} \times \text{Volume} \\ \text{ethanol} &= 0.789 \times 500 \\ &= 394.5\text{g}\end{aligned}$$

$$\begin{aligned}\text{amount} &= \text{mass}/M_r \\ &= 394.5/46.0 \\ &= 8.576 \text{ mol}\end{aligned}$$

$$\begin{aligned}\text{Number of molecules} &= \text{amount} \times 6.02 \times 10^{23} \\ &= 8.576 \times 6.02 \times 10^{23} \\ &= 5.16 \times 10^{24} (\text{to 3 sig fig})\end{aligned}$$

### Questions

- 4.1) A chemist needed to add  $0.100 \text{ mol}$  of ethanol ( $\text{CH}_3\text{CH}_2\text{OH}$ ) to a reaction mixture. What volume of ethanol should she measure out? The density of ethanol is  $0.789 \text{ g cm}^{-3}$
- 4.2) A saturated solution of sodium chloride is described as  $0.360 \text{ kg NaCl}$  per  $1 \text{ kg}$  of Water. If the density of water is  $1 \text{ g cm}^{-3}$ , what would be the molar concentration of saturated sodium chloride in  $\text{mol dm}^{-3}$
- 4.3) An oil has a density of  $0.91 \text{ g cm}^{-3}$ . A droplet of the oil has a volume of  $5.0 \times 10^{-2} \text{ cm}^3$ . The approximate  $M_r$  of the oil is 880. Calculate the number of molecules of oil in the droplet
- 4.4) The density of calcium is  $1.55 \text{ g cm}^{-3}$ . Calculate its molar volumes, i.e. the volume (in  $\text{m}^3$ ) occupied by  $1 \text{ mol}$ .
- 4.5) A fighter plane holds  $0.2230 \text{ m}^3$  of hydrazine ( $\text{N}_2\text{H}_4$ ) and  $0.860 \text{ m}^3$  of methanol ( $\text{CH}_3\text{OH}$ ) in its fuel tank. Density of  $\text{N}_2\text{H}_4 = 1.021 \text{ g cm}^{-3}$  Density of  $\text{CH}_3\text{OH} = 0.7918 \text{ g cm}^{-3}$
- What is the total mass of the two substances?
  - What is the total number of molecules in the fuel tank
- 4.6) Concentrated hydrochloric acid is sold as a 38% by mass solution with a density of  $1.2 \text{ g cm}^{-3}$ . Calculate the concentration of this solution in  $\text{mol dm}^{-3}$
- 4.7) Given that the density of pure water is  $1.0 \text{ kg dm}^{-3}$ , calculate the concentration of pure water in  $\text{mol dm}^{-3}$ .

## Parts per million (ppm)

Concentrations can be given also in parts per million. This is often used for gases in the atmosphere or in exhausts, and pollutants in water.

$$\text{parts per million (ppm) of substance, by mass} = \frac{\text{mass of substance in mixture}}{\text{total mass of mixture}} \times 1000\ 000$$

**Example** : Blood plasma typically contains 20 parts per million (ppm) of magnesium, by mass. Calculate the mass of magnesium, in grams, present in 100 g of plasma.

$$\text{parts per million (ppm) of substance, by mass} = \frac{\text{mass of substance in mixture}}{\text{total mass of mixture}} \times 1000\ 000$$

$$20 = \frac{\text{mass of substance in mixture}}{100} \times 1000\ 000$$

$$\begin{aligned} \text{mass of substance in mixture} &= 20 \times 100 / 1000\ 000 \\ &= 2 \times 10^{-3} \text{ g} \end{aligned}$$

5.1) 1 kg of a solution contains 0.100 mol of calcium ions,  $\text{Ca}^{2+}$ . What is the concentration of the calcium ions by mass in parts per million (ppm)?

5.2) A solution contains 76 ppm of a solute. Calculate the mass of the solute dissolved in 1 kg of this solution.

5.3) A solution contains 187 ppm of a solute. Calculate the mass of the solute dissolved in 0.5 kg of this solution.

## Answers

- 1.1)  $0.330 \text{ mol dm}^{-3}$
- 1.2)  $0.65 \text{ mol dm}^{-3}$
- 1.3)  $0.198 \text{ mol dm}^{-3}$
- 1.4) 13.3g
- 1.5)  $2.95 \text{ mol dm}^{-3}$
- 1.6) a) 9.53g
- b)  $38.1 \text{ g dm}^{-3}$
- 1.7) 5.08g
- 1.8)  $0.0174 \text{ mol dm}^{-3}$
- 1.9)  $4.5 \times 10^{-3} \text{ mol}$
- 1.10)  $0.9 \text{ g dm}^{-3}$
- 1.11)  $2.01 \times 10^{-4} \text{ mol dm}^{-3}$

- 2.1)  $0.357 \text{ mol dm}^{-3}$
- 2.2)  $200 \text{ cm}^3$
- 2.3)  $5 \text{ dm}^3$
- 2.4)  $575 \text{ cm}^3$
- 2.5)  $95 \text{ cm}^3$

- 3.1)  $\text{NaCl} = 0.34 \text{ mol dm}^{-3}$   $\text{HCl} = 0.10 \text{ mol dm}^{-3}$
- 3.2)  $\text{KCl} = 0.025 \text{ mol dm}^{-3}$   $\text{HCl} = 0.1125 \text{ mol dm}^{-3}$
- 3.3 ratio 3NaCl : 1 KCl

- 4.1)  $5.83 \text{ cm}^3$
- 4.2)  $6.15 \text{ mol dm}^{-3}$
- 4.3)  $3.1 \times 10^{19}$
- 4.4)  $2.59 \times 10^{-5} \text{ m}^3 \text{ mol}^{-1}$
- 4.5) a) 908 kg
- b)  $1.71 \times 10^{28}$
- 4.6)  $12.5 \text{ mol dm}^{-3}$
- 4.7)  $55.5 \text{ mol dm}^{-3}$

- 5.1) 4010ppm
- 5.2) 0.076g
- 5.3) 0.0935g