

Practical Guide AQA

This guide includes details about the required practicals for A-level chemistry. It also contains information about other experiments that often occur in A-level examinations. You may be asked to describe these experiments in details or be asked about reasons for doing individual steps.

You may be asked about other unfamiliar experiments but these will be using the skills and techniques that are described in the following experiments.

Safety and hazards

- Irritant - dilute acid and alkalis- wear goggles
- Corrosive- stronger acids and alkalis wear goggles
- Flammable – keep away from naked flames
- Toxic – wear gloves- avoid skin contact- wash hands after use
- Oxidising- Keep away from flammable / easily oxidised materials

Hazardous substances in low concentrations or amounts will not pose the same risks as the pure substance.

Heating in a crucible

This method could be used for measuring mass loss in various thermal decomposition reactions and also for mass gain when reacting magnesium in oxygen.

The water of crystallisation in calcium sulphate crystals can be removed as water vapour by heating as shown in the following equation.

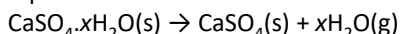

Method.

- Weigh an empty clean dry crucible and lid .
- Add 2g of hydrated calcium sulphate to the crucible and weigh again
- Heat strongly with a Bunsen for a couple of minutes
- Allow to cool
- Weigh the crucible and contents again
- Heat crucible again and reweigh until you reach a constant mass (do this to ensure reaction is complete).

Large amounts of hydrated calcium sulphate, such as 50g, should not be used in this experiment as the decomposition is likely to be incomplete.

The crucible needs to be dry otherwise a wet crucible would give an inaccurate result. It would cause mass loss to be too large as the water would be lost when heating.

The lid improves the accuracy of the experiment as it prevents loss of solid from the crucible but should be loose fitting to allow gas to escape.

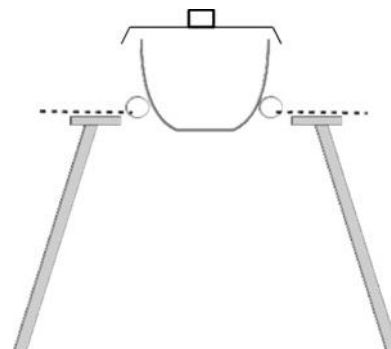

Small amounts of the solid , such as 0.100 g, should **not** be used in this experiment as the percentage uncertainties in weighing will be too high.

Example 1. 3.51 g of hydrated zinc sulphate were heated and 1.97 g of anhydrous zinc sulphate were obtained. Use these data to calculate the value of the integer x in $\text{ZnSO}_4 \cdot x\text{H}_2\text{O}$

Calculate the mass of H_2O = $3.51 - 1.97 = 1.54\text{g}$

Calculate moles of ZnSO_4	= $\frac{1.97}{161.5}$	Calculate moles of H_2O	= $\frac{1.54}{18}$
	= 0.0122		= 0.085

Calculate ratio of mole of ZnSO_4 to H_2O	= $\frac{0.0122}{0.0122}$		= $\frac{0.085}{0.0122}$
	= 1		= 7
			X = 7

Using a gas syringe

Gas syringes can be used for a variety of experiments where the volume of a gas is measured, possibly to work out moles of gas or to follow reaction rates.

The volume of a gas depends on pressure and temperature so when recording volume it is important to note down the temperature and pressure of the room.

Moles of gas can be calculated from gas volume (and temperature and pressure) using ideal gas equation $PV = nRT$

Potential errors in using a gas syringe

- gas escapes before bung inserted
- syringe sticks
- some gases like carbon dioxide or sulphur dioxide are soluble in water so the true amount of gas is not measured.

Make sure you don't leave gaps in your diagram where gas could escape

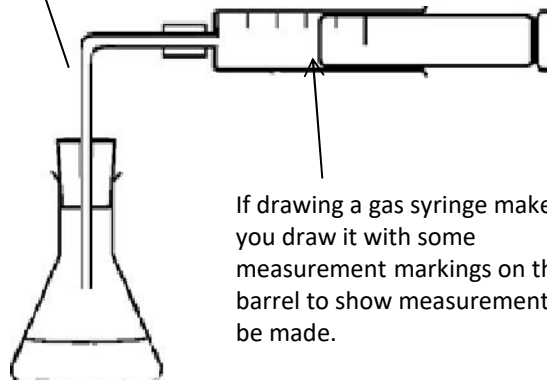

If drawing a gas syringe make sure you draw it with some measurement markings on the barrel to show measurements can be made.

Method for using a gas syringe to calculate the Mr of propanone

1. Extract 0.20 cm³ of propanone into a hypodermic syringe and then measure the mass of this syringe
2. using hand protection, remove a gas syringe from the oven and note the volume of air already in the barrel – about 5 cm³.
3. inject the propanone through the self-seal cap into the barrel. The plunger will move straight away.
4. Put the gas syringe back into the oven.
5. Measure the mass of the empty hypodermic syringe immediately.
6. After a few minutes measure the volume of the gas in the gas syringe, record the temperature of the oven shelf and the pressure of the room.

Example 2 : 0.150g of a volatile liquid was injected into a sealed gas syringe. The gas syringe was placed in an oven at 70°C at a pressure of 100kPa and a volume of 80cm³ was measured. What is the Mr of the volatile liquid ? ($R = 8.31$)

$$\text{moles} = PV/RT$$

$$= 100\,000 \times 0.00008 / (8.31 \times 343)$$

$$= 0.00281 \text{ mol}$$

$$\text{Mr} = \text{mass}/\text{moles}$$

$$= 0.15 / 0.00281$$

$$= 53.4 \text{ g mol}^{-1}$$

$$100 \text{ kPa} = 100\,000 \text{ Pa}$$

$$80 \text{ cm}^3 = 0.00008 \text{ m}^3$$

Required activity 1. Make up a volumetric solution and carry out a simple acid–base titration

Making a solution

- Weigh the sample bottle containing the required mass of solid on a 2 dp balance
- Transfer to beaker
- Reweigh empty sample bottle
- Record the difference in mass

• Add 100cm³ of distilled water to the beaker. Use a glass rod to stir to help dissolve the solid.

• Sometimes the substance may not dissolve well in cold water so the beaker and its contents could be heated gently until all the solid had dissolved.

- Pour solution into a 250cm³ graduated flask via a funnel.
- Rinse beaker and funnel and add washings from the beaker and glass rod to the volumetric flask.
- make up to the mark with distilled water using a dropping pipette for last few drops.
- Invert flask several times to ensure uniform solution.

Alternatively the known mass of solid in the weighing bottle could be transferred to beaker, washed and washings added to the beaker.

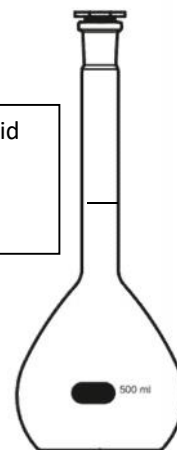

Remember to fill so the bottom of the meniscus sits on the line on the neck of the flask. With dark liquids like potassium manganate it can be difficult to see the meniscus.

Shake the volumetric flask thoroughly to ensure a uniform concentration



Graduated/volumetric flask

A graduated flask has one mark on the neck which the level to fill to get the accurate volume. Do not heat or put hot solutions in the volumetric flask because the heat would cause the flask to expand and the volume would then be incorrect.

Measuring mass accurately:

In many experiments the best method for measuring mass is

1. Measure mass on 2 or 3d.p. balance of a weighing bottle with the required quantity of solid in it
2. Empty mass into reaction vessel/flask
3. Reweigh the now empty weighing bottle
4. Subtract the mass of the empty weighing bottle from the first reading to give exact of mass actually added.

Dilutions

Diluting a solution

- Pipette 25cm³ of original solution into a 250cm³ volumetric flask
- make up to the mark with distilled water using a dropping pipette for last few drops.
- Invert flask several times to ensure uniform solution.

Using a volumetric pipette is more accurate than a measuring cylinder because it has a smaller uncertainty

Use a teat pipette to make up to the mark in volumetric flask to ensure volume of solution accurately measured and one doesn't go over the line

Titration Required activity 1. Make up a volumetric solution and carry out a simple acid–base titration

General Method

- rinse equipment (burette with acid, pipette with alkali, conical flask with distilled water)
- pipette 25 cm³ of alkali into conical flask
- touch surface of alkali with pipette (to ensure correct amount is added)
- adds acid solution from burette
- make sure the jet space in the burette is filled with acid
- add a few drops of indicator and refer to colour change at end point
- phenolphthalein [pink (alkali) to colourless (acid): end point pink colour just disappears] [use if NaOH is used]
- methyl orange [yellow (alkali) to red (acid): end point orange] [use if HCl is used]
- use a white tile underneath the flask to help observe the colour change
- add acid to alkali whilst **swirling the mixture** and **add acid drop wise at end point**
- note burette reading before and after addition of acid
- repeats titration until **at least 2 concordant results** are obtained- two readings within 0.1 of each other

Titration is done often to find out the concentration of one substance by reacting it with another substance of known concentration.

They are often done with neutralisation reactions, but can be done with redox reactions.

One substance (generally the one we don't know the concentration) is put in the conical flask. It is measured using a volumetric pipette.

The other substance is placed in the burette

However, the standard phrase: **titrate solution A with solution B** means that A should be in the conical flask and B should be in the burette.

A conical flask is used in preference to a beaker because it is easier to swirl the mixture in a conical flask without spilling the contents.

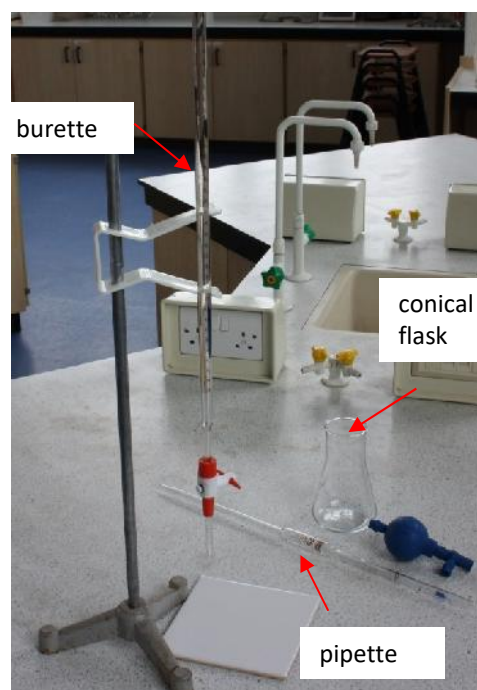

Detailed Method for Titration

Using the pipette

- rinse pipette with substance to go in it (often alkali).
- pipette 25 cm³ of solution A into conical flask. The volumetric pipette will have a mark on its neck to show the level to fill to. The bottom of the meniscus should sit on this line.
- touch surface of solution with pipette (to ensure correct amount is added). A small amount of solution will be left in the pipette at this stage. The calibration of the pipette will take into account this effect. It should not be forced out.

Make sure bottom of meniscus is on line on neck of pipette

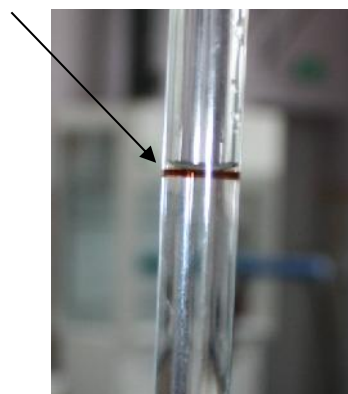

Using the burette

The burette should be rinsed out with substance that will be put in it. If it is not rinsed out the acid or alkali added may be diluted by residual water in the burette or may react with substances left from a previous titration. This would lead to the concentration of the substance being lowered and a larger titre being delivered.

Don't leave the funnel in the burette because small drops of liquid may fall from the funnel during the titration leading to a false burette reading (would give a lower titre volume)

make sure the jet space in the burette is **filled** with the solution and air bubbles are removed.

If the jet space in the burette is not filled properly prior to commencing the titration it will lead to errors if it then fills during the titration, leading to a larger than expected titre reading.



Read the bottom of the meniscus on the burette

This is reading 9.00cm^3

Even though a burette has marking reading to 0.1cm^3 , the burette readings should always be given to 2dp either ending in 0.00 or 0.05 . 0.05cm^3 is the volume of 1 drop of solution delivered from a burette and so this is the smallest difference in readings that can be measured. If the bottom of the meniscus sits on a line it should end with a 0.00 as in the above example 9.00cm^3 . If the meniscus sits between two lines it should end 0.05 . e.g. if the bottom of the meniscus sits between the lines marked 9.1 and 9.2, you should record 9.15

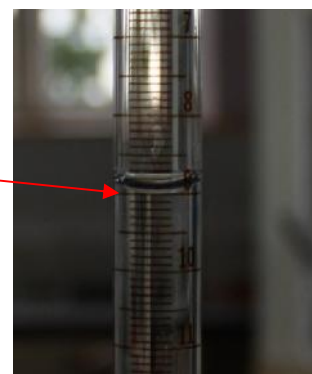

Adding indicator

Add **a few drops of indicator** and refer to colour change at end point

Indicators are generally weak acids so only add a few drops of them. If too much is added they will affect the titration result

phenolphthalein

If acid is added from the burette the colour change would be pink (alkali) to colourless (acid): end point pink colour just disappears [use with titrations using strong alkalis e.g. NaOH]



phenolphthalein
Alkali colour



phenolphthalein acid
colour

Methyl orange

Methyl orange is a suitable indicator for neutralisation reactions where strong acids are used. It is red in acid and yellow in alkali. It is orange at the end point.



Methyl orange
Alkali colour



Methyl orange
end point



Methyl orange
acid colour

Use a white tile underneath the flask to help observe the colour change

Add solution from burette whilst **swirling the mixture** and **add drop-wise at end point**

Distilled water can be added to the conical flask during a titration to wash the sides of the flask so that all the acid on the side is washed into the reaction mixture to react with the alkali.
It does not affect the titration reading as water does not react with the reagents or change the number of moles of acid added.

note burette reading before and after addition of solution
repeats titration until at least 2 concordant results are obtained- two readings within 0.1 of each other

A single titration could be flawed. Repeating allows for anomalous titres to be spotted and discounted

Recording results

- Results should be clearly recorded in a table
- Result should be recorded in full (i.e. both initial and final readings)
- Record titre volumes to 2dp (0.05 cm³)

Titration number	1	2	3
Initial burette reading (cm ³)	0.50	2.50	1.55
Final burette reading (cm ³)	24.50	27.00	25.95
Titre (cm ³)	24.00	24.50	24.40

Safety precautions

Acids and alkalis are corrosive
(at low concentrations acids are irritants)
Wear eye protection and gloves

If spilled immediately wash affected parts after spillage

If substance is unknown treat it as potentially toxic and wear gloves.

Testing batches

In quality control it will be necessary to do titrations/testing on several samples as the amount/concentration of the chemical being tested may vary between samples.

Only distilled water should be used to wash out conical flasks between titrations because it does not add any extra moles of reagents

If **2 or 3 values are within 0.10cm³** and therefore **concordant** or close then we can say results are accurate and **repeatable** and **the titration technique is good and consistent**

Working out average titre results

Only make an average of the concordant titre results

$$\text{Average titre} = (24.50 + 24.40) / 2 = 24.45$$

Common Titration Equations

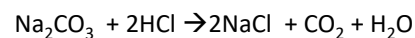
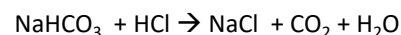
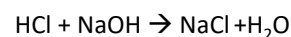
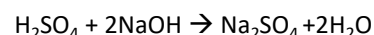
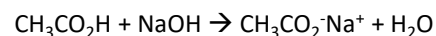

Titration mixtures

If titrating a mixture to work out the concentration of an active ingredient it is necessary to consider if the mixture contains other substances that have acid base properties.

If they don't have acid base properties we can titrate with confidence.

Other useful manganate titrations

With hydrogen peroxide

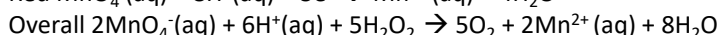
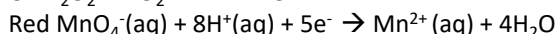
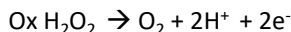

With ethanedioate

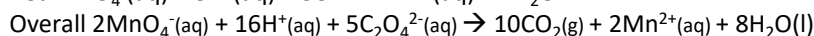
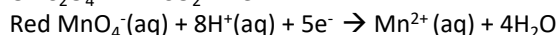
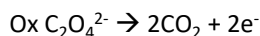

The reaction between MnO_4^- and $\text{C}_2\text{O}_4^{2-}$ is slow to begin with (as the reaction is between two negative ions). To do as a titration the conical flask can be heated to 60°C to speed up the initial reaction.

With Iron (II) ethanedioate both the Fe^{2+} and the $\text{C}_2\text{O}_4^{2-}$ react with the MnO_4^-
 1MnO_4^- reacts with 5Fe^{2+} and 2MnO_4^- reacts with $5\text{C}_2\text{O}_4^{2-}$

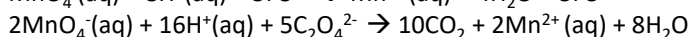
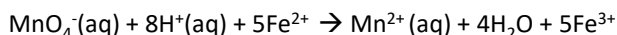

So overall

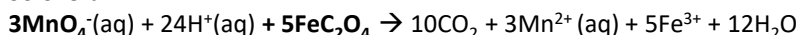

So overall the ratio is **3** MnO_4^- to **5** FeC_2O_4

Example 4

A 1.412 g sample of impure $\text{FeC}_2\text{O}_4 \cdot 2\text{H}_2\text{O}$ was dissolved in an excess of dilute sulphuric acid and made up to 250 cm^3 of solution. 25.0 cm^3 of this solution decolourised 23.45 cm^3 of a $0.0189 \text{ mol dm}^{-3}$ solution of potassium manganate(VII).

What is the percentage by mass of $\text{FeC}_2\text{O}_4 \cdot 2\text{H}_2\text{O}$ in the original sample?

Step 1 : find moles of KMnO_4

moles = conc x vol

$$0.0189 \times 23.45/1000$$

$$= 4.43 \times 10^{-4} \text{ mol}$$

Step 2 : using balanced equation find moles $\text{FeC}_2\text{O}_4 \cdot 2\text{H}_2\text{O}$ in 25 cm^3

= moles of $\text{KMnO}_4 \times 5/3$ (see above for ratio)

$$= 7.39 \times 10^{-4} \text{ mol}$$

Step 3 : find moles $\text{FeC}_2\text{O}_4 \cdot 2\text{H}_2\text{O}$ in 250 cm^3

$$= 7.39 \times 10^{-4} \text{ mol} \times 10$$

$$= 7.39 \times 10^{-3} \text{ mol}$$

Step 4 : find mass of $\text{FeC}_2\text{O}_4 \cdot 2\text{H}_2\text{O}$ in $7.39 \times 10^{-3} \text{ mol}$

$$\text{mass} = \text{moles} \times \text{Mr} = 7.39 \times 10^{-3} \times 179.8 = 1.33 \text{ g}$$

Step 5 ; find % mass

$$\% \text{mass} = 1.33/1.412 \times 100$$

$$= 94.1\%$$

EDTA titrations

The formation of the stable EDTA complex with metal ions can with the choice of suitable indicator be done in a quantitative titration.

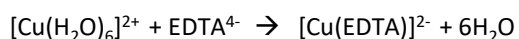

Always the same 1:1 ratio with any metal ion

Example 5

A river was polluted with copper(II) ions. 25.0 cm^3 sample of the river water was titrated with a $0.0150 \text{ mol dm}^{-3}$ solution of EDTA^{4-} , 6.45 cm^3 were required for complete reaction.

Calculate the concentration, in mol dm^{-3} , of copper(II) ions in the river water.

Step 1 : find moles of EDTA^{4-}

$$\text{moles} = \text{conc} \times \text{vol} = 0.0150 \times 6.45/1000$$

$$= 9.68 \times 10^{-5} \text{ mol}$$

Step 2 : using balanced equation find moles Cu^{2+}

1:1 ratio

$$= 9.68 \times 10^{-5} \text{ mol}$$

Step 3 : find conc Cu^{2+} in 25 cm^3

$$= 9.68 \times 10^{-5} / 0.025$$

$$= 0.00387 \text{ mol dm}^{-3}$$

Uncertainty

Readings and Measurements

Readings

the values found from a single judgement when using a piece of equipment

Measurements

the values taken as the difference between the judgements of two values (e.g. using a burette in a titration)

Calculating Apparatus Uncertainties

Each type of apparatus has a sensitivity uncertainty

- balance ± 0.001 g (if using a 3 d.p. balance)
- volumetric flask ± 0.1 cm³
- 25 cm³ pipette ± 0.1 cm³
- burette (start & end readings and end point) ± 0.15 cm³

Calculate the percentage error for each piece of equipment used by

$$\% \text{ uncertainty} = \pm \frac{\text{uncertainty}}{\text{Measurement made on apparatus}} \times 100$$

e.g. for burette

$$\% \text{ uncertainty} = 0.15 / \text{average titre result} \times 100$$

To calculate the maximum **total** percentage apparatus uncertainty in the final result add all the individual equipment uncertainties together.

In general, if uncertainty is not indicated on apparatus, the following assumptions are made:

For an analogue scale-

The uncertainty of a reading (one judgement) is at least ± 0.5 of the smallest scale reading.

The uncertainty of a measurement (two judgements) is at least ± 1 of the smallest scale reading.

- If the apparatus has a digital scale, the uncertainty is \pm the resolution of the apparatus in each measurement

Uncertainty of a measurement using a burette.

If the burette used in the titration had an uncertainty for each reading of ± 0.05 cm³ then during a titration two readings would be taken so the uncertainty on the titre volume would be ± 0.10 cm³. Then often another 0.05 is added on because of uncertainty identifying the end point colour change

Reducing uncertainties in a titration

Replacing measuring cylinders with pipettes or burettes which have lower apparatus uncertainty will lower the error.

To reduce the uncertainty in a burette reading it is necessary to make the titre a larger volume. This could be done by: increasing the volume and concentration of the substance in the conical flask or by decreasing the concentration of the substance in the burette.

To decrease the apparatus uncertainties you can either decrease the sensitivity uncertainty by using apparatus with a greater resolution (finer scale divisions) or you can increase the size of the measurement made.

Reducing uncertainties in measuring mass

Using a more accurate balance or a larger mass will reduce the uncertainty in weighing a solid

Weighing sample before and after addition and then calculating difference will ensure a more accurate measurement of the mass added.

If looking at a series of measurements in an investigation, the experiments with the smallest readings will have the highest experimental uncertainties.

Calculating the percentage difference between the actual value and the calculated value

If we calculated an Mr of 203 and the real value is 214, then the calculation is as follows:

Calculate difference $214 - 203 = 11$

$$\% = 11 / 214 \times 100$$

$$= 5.41\%$$

If the %**uncertainty** due to the apparatus $<$ percentage difference between the actual value and the calculated value then there is a discrepancy in the result due to other errors.

If the %**uncertainty** due to the apparatus $>$ percentage difference between the actual value and the calculated value then there is no discrepancy and all errors in the results can be explained by the sensitivity of the equipment.

Required activity 2. Measurement of an enthalpy change

Measuring the Enthalpy Change for a Reaction Experimentally

Calorimetric method

For a reaction in solution we use the following equation

energy change = mass of solution x heat capacity x temperature change

$$Q \text{ (J)} = m \text{ (g)} \times c_p \text{ (J g}^{-1}\text{K}^{-1}) \times \Delta T \text{ (K)}$$

This equation will only give the energy for the actual quantities used. Normally this value is converted into the energy change per mole of one of the reactants. (The enthalpy change of reaction, ΔH)

Calorimetric method

One type of experiment is one in which substances are mixed in an insulated container and the temperature rise measured.

This could be a solid dissolving or reacting in a solution or it could be two solutions reacting together

General method

- washes the equipment (cup and pipettes etc) with the solutions to be used
- dry the cup after washing
- put polystyrene cup in a beaker **for insulation and support**
- Measure out desired volumes of solutions with volumetric pipettes and transfer to insulated cup
- clamp thermometer into place making sure the thermometer bulb is immersed in solution
- measure the initial temperatures of the solution or both solutions if 2 are used. Do this every minute for 2-3 minutes
- At minute 3 transfer second reagent to cup. If a solid reagent is used then add the solution to the cup first and then add the solid weighed out on a balance.
- If using a solid reagent then use 'before and after' weighing method
- stirs mixture (**ensures that all of the solution is at the same temperature**)
- Record temperature every minute after addition for several minutes

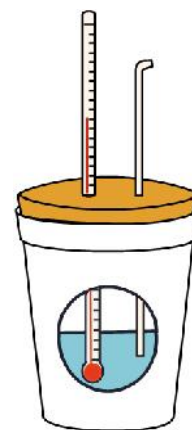

If the reaction is slow then the exact temperature rise can be difficult to obtain as cooling occurs simultaneously with the reaction

To counteract this we take readings at regular time intervals and extrapolate the temperature curve/line back to the time the reactants were added together.

We also take the temperature of the reactants for a few minutes before they are added together to get a better average temperature. If the two reactants are solutions then the temperature of both solutions need to be measured before addition and an average temperature is used.

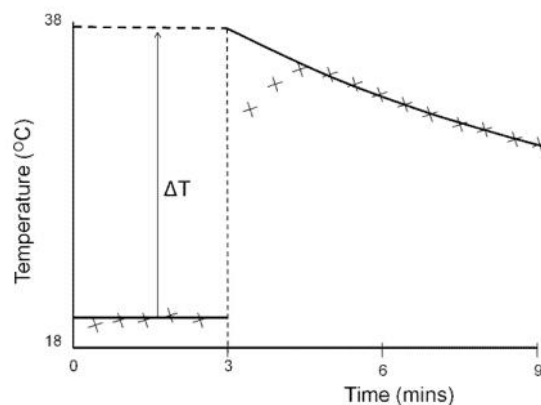

Errors in this method

- energy transfer from surroundings (usually loss)
- approximation in specific heat capacity of solution. The method assumes all solutions have the heat capacity of water.
- neglecting the specific heat capacity of the calorimeter- we ignore any energy absorbed by the apparatus.
- reaction or dissolving may be incomplete or slow.
- Density of solution is taken to be the same as water.

Read question carefully. It may be necessary to describe:

- Method
- Drawing of graph with extrapolation
- Description of the calculation

Calculating the enthalpy change of reaction, ΔH , from experimental data

General method

1. Using $q = m \times c_p \times \Delta T$ calculate energy change for quantities used
2. Work out the moles of the reactants used
3. Divide q by the number of moles of the reactant not in excess to give ΔH
4. Add a sign and unit (divide by a thousand to convert J mol^{-1} to kJ mol^{-1})

The heat capacity of water is $4.18 \text{ J g}^{-1}\text{K}^{-1}$. In any reaction where the reactants are dissolved in water we assume that the heat capacity is the same as pure water.

Also assume that the solutions have the density of water, which is 1 g cm^{-3} . Eg 25 cm^3 will weigh 25 g

Example 6. Calculate the enthalpy change of reaction for the reaction where 25.0 cm^3 of 0.20 M copper sulphate was reacted with 0.01 mol (excess of zinc). The temperature increased 7.0°C .

Step 1: Calculate the energy change for the amount of reactants in the test tube.

$$Q = m \times c_p \times \Delta T$$

$$Q = 25 \times 4.18 \times 7$$

$$Q = 731.5 \text{ J}$$

Note the mass is the mass of the copper sulphate solution only. Do not include mass of zinc powder.

Step 2: calculate the number of moles of the reactant not in excess.

$$\begin{aligned} \text{moles of CuSO}_4 &= \text{conc} \times \text{vol} \\ &= 0.2 \times 25/1000 \\ &= 0.005 \text{ mol} \end{aligned}$$

If you are not told what is in excess, then you need to work out the moles of both reactants and work out using the balanced equation which one is in excess.

Step 3: calculate the enthalpy change per mole which is often called ΔH (the enthalpy change of reaction)

$$\begin{aligned} \Delta H &= Q / \text{no of moles} \\ &= 731.5 / 0.005 \\ &= 146300 \text{ J mol}^{-1} \\ &= 146 \text{ kJ mol}^{-1} \text{ to 3 sf} \end{aligned}$$

Finally add in the sign to represent the energy change: if temp increases the reaction is exothermic and is given a minus sign e.g. -146 kJ mol^{-1}

Remember in these questions: **sign, unit**

Example 7. 25.0 cm^3 of 2.0 M HCl was neutralised by 25.0 cm^3 of 2.0 M NaOH. The Temperature increased 13.5°C . What was the energy change per mole of HCl?

Step 1: Calculate the energy change for the amount of reactants in the test tube.

$$Q = m \times c_p \times \Delta T$$

$$Q = 50 \times 4.18 \times 13.5$$

$$Q = 2821.5 \text{ J}$$

Note the mass equals the mass of acid + the mass of alkali, as they are both solutions.

Step 2: calculate the number of moles of the HCl.

$$\begin{aligned} \text{moles of HCl} &= \text{conc} \times \text{vol} \\ &= 2 \times 25/1000 \\ &= 0.05 \text{ mol} \end{aligned}$$

Step 3: calculate ΔH the enthalpy change per mole which might be called the enthalpy change of neutralisation

$$\begin{aligned} \Delta H &= Q / \text{no of moles} \\ &= 2821.5 / 0.05 \\ &= 56430 \text{ J mol}^{-1} \\ &= -56.4 \text{ kJ mol}^{-1} \text{ to 3 sf} \end{aligned}$$

Exothermic and so is given a minus sign

Remember in these questions: **sign, unit,**

Often Hess's law cycles are used to measure the enthalpy change for a reaction that cannot be measured directly by experiments. Instead alternative reactions are carried out that can be measured experimentally.

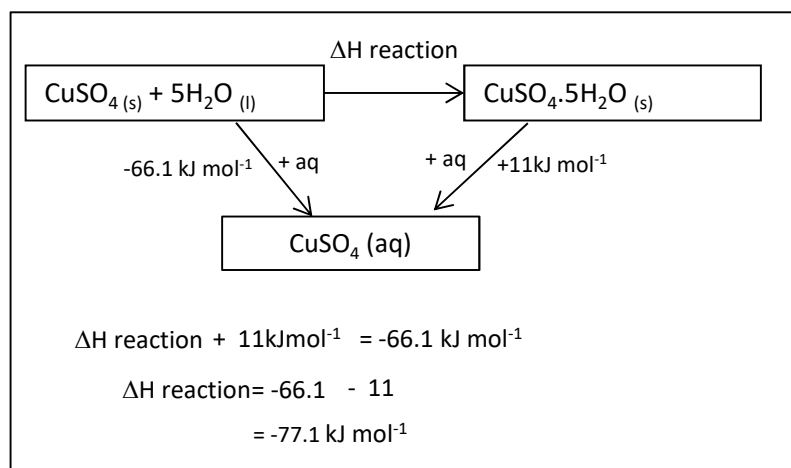

This Hess's law is used to work out the enthalpy change to form a hydrated salt from an anhydrous salt.

This cannot be done experimentally because it is impossible to add the exact amount of water without the solid dissolving and it is not easy to measure the temperature change of a solid.

Instead both salts are dissolved in excess water to form a solution of copper sulphate. The temperature changes can be measured for these reactions.

Detailed method for measuring enthalpy change of solution of anhydrous copper(II) sulfate

1. Weigh out between 3.90 g and 4.10 g of anhydrous copper(II) sulfate in a dry weighing bottle. The precise mass should be recorded.
2. Using a volumetric pipette, place 25 cm³ of deionised water into a polystyrene cup and record its temperature at the beginning (t=0), start the timer and then record the temperature again every minute, stirring the liquid continuously.
3. At the fourth minute, add the powdered anhydrous copper(II) sulfate rapidly to the water in the polystyrene cup and continue to stir, but do not record the temperature.
4. Reweigh the empty weighing bottle
5. At the fifth minute and for every minute up to 15 minutes, stir and record the temperature of the solution in the polystyrene cup.
6. Plot a graph of temperature (on the y-axis) against time. Draw two separate best fit lines; one, which joins the points before the addition, and one, which joins the points after the addition, extrapolating both lines to the fourth minute.
7. Use your graph to determine the temperature change at the fourth minute, which theoretically should have occurred immediately on addition of the solid.
8. Using $q = m \times c_p \times \Delta T$ calculate energy change
 $= 20 \times 4.18 \times \Delta T$
9. Calculate $\Delta H_{\text{solution}}$ by dividing q by number of moles of anhydrous copper(II) sulfate in mass added

The above method is then repeated using hydrated copper sulfate. The two $\Delta H_{\text{solution}}$ can then be used to calculate the ΔH for the enthalpy change of forming a hydrated salt as in the example above

Measuring Enthalpies of Combustion using Flame Calorimetry

Enthalpies of combustion can be calculated by using calorimetry. Generally the fuel is burnt and the flame is used to heat up water in a metal cup.

Need to measure

- mass of spirit burner before and after
- Temperature change of water
- Volume of water in cup

Errors in this method

- energy losses from calorimeter
- Incomplete combustion of fuel
- Incomplete transfer of energy
- Evaporation of fuel after weighing
- Heat capacity of calorimeter not included
- Measurements not carried out under standard conditions as H₂O is gas, not liquid, in this experiment

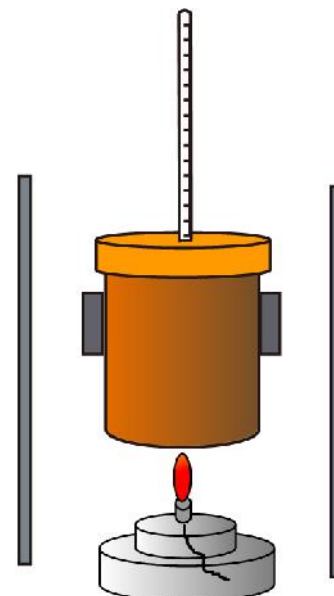

Example 8. Calculate the enthalpy change of combustion for the reaction where 0.65g of propan-1-ol was completely combusted and used to heat up 150g of water from 20.1 to 45.5°C

Step 1: Calculate the energy change used to heat up the water.

$$Q = m \times c_p \times \Delta T$$

$$Q = 150 \times 4.18 \times 25.4$$

$$Q = 15925.8 \text{ J}$$

Note the mass in this equation is the mass of water in the calorimeter and not the alcohol

Step 2 : calculate the number of moles of alcohol combusted.

$$\begin{aligned} \text{moles of propan-1-ol} &= \text{mass} / M_r \\ &= 0.65 / 60 \\ &= 0.01083 \text{ mol} \end{aligned}$$

Step 3 : calculate the enthalpy change per mole which is called ΔH_c (the enthalpy change of combustion)

$$\begin{aligned} \Delta H &= Q / \text{no of moles} \\ &= 15925.8 / 0.01083 \\ &= 1470073 \text{ J mol}^{-1} \\ &= 1470 \text{ kJ mol}^{-1} \text{ to 3 sf} \end{aligned}$$

Finally add in the sign to represent the energy change: if temp increases the reaction is exothermic and is given a minus sign eg **-1470 kJ mol⁻¹**

Remember in these questions: **sign, unit**

Required Activity 3. Investigation of how the rate of a reaction changes with temperature

Experiment: sodium thiosulfate and hydrochloric acid

In the experiment between sodium thiosulfate and hydrochloric acid we usually measure reaction rate as $1/\text{time}$ where the time is the time taken for a cross placed underneath the reaction mixture to disappear due to the cloudiness of the Sulfur .

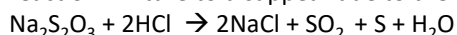

This is an approximation for initial rate of reaction as it does not include the change in concentration term. We can use this because we can assume the amount of Sulfur produced to block out the cross in each experiment is the same and constant so each time we do the experiment the same amount of sulphur is produced. The change in concentration of sulfur is therefore the same for each experiment so only the time taken to reach this concentration is relevant.

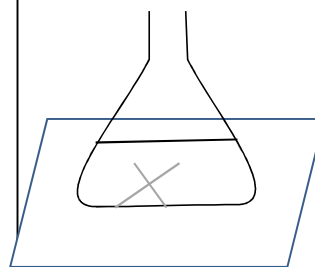

Typical Method

- Measure 10 cm³ of 0.2M hydrochloric acid and 10 cm³ of sodium thiosulfate in separate clean measuring cylinders. Put the solutions in separate boiling tubes
- Choose a temperature to investigate use water bath to get the two solutions to that temperature by placing the boiling tubes in the water bath.
- Place the flask on the centre of the large cross; first add the sodium thiosulfate to the flask. Then add the hydrochloric acid and start the stopwatch and swirl to mix the solutions.
- Stop the clock when the cross disappears and note the time.
- Repeat the experiment for four more different temperatures (maximum temperature should be 70 °C).

Analysis of results to calculate Activation Energy

The Arrhenius equation can be rearranged

$$\ln k = \text{constant} - E_a/(RT)$$

k is proportional to the rate of reaction so $\ln k$ can be replaced by $\ln(\text{rate})$

From plotting a graph of $\ln(\text{rate})$ or $\ln k$ against $1/T$ the activation energy can be calculated from measuring the gradient of the line

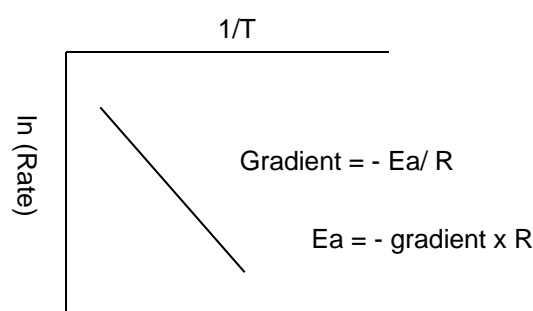

Example 8

Temperature T (K)	1/T	time t (s)	1/t	Ln (1/t)
297.3	0.003364	53	0.018868	-3.9703
310.6	0.00322	24	0.041667	-3.1781
317.2	0.003153	16	0.0625	-2.7726
323.9	0.003087	12	0.083333	-2.4849
335.6	0.00298	6	0.166667	-1.7918

$$\text{gradient} = \frac{y_2 - y_1}{x_2 - x_1}$$

The gradient should always be -ve

In above example gradient = -5680

$$\begin{aligned} E_a &= -\text{gradient} \times R \quad (8.31) \\ &= -(-5680) \times 8.31 \\ &= 47200 \text{ J mol}^{-1} \end{aligned}$$

The unit of E_a using this equation will be J mol^{-1} . Convert into kJ mol^{-1} by dividing 1000

$$E_a = +47.2 \text{ kJ mol}^{-1}$$

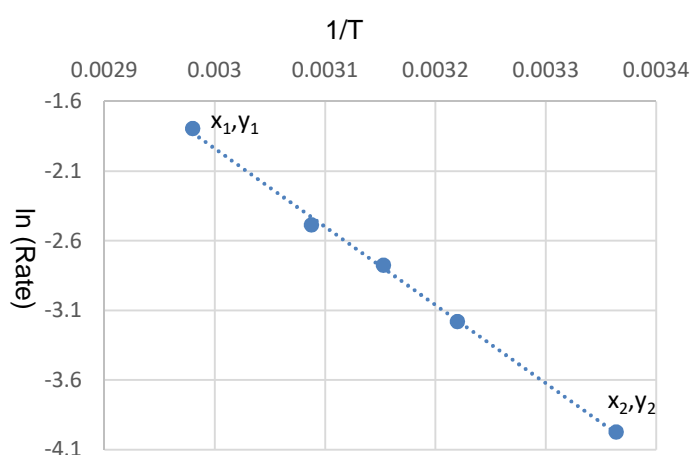

use a line of best fit
use all graph paper
choose points far apart on the graph to calculate the gradient

Required activity 4: Testing for cations: Group 2, NH₄⁺

Method: adding dilute sodium hydroxide

- Place about 10 drops of 0.1 mol dm⁻³ metal ion solution in a test tube.
- Add about 10 drops of 0.6 mol dm⁻³ sodium hydroxide solution, mixing well.
- Continue to add sodium hydroxide solution, dropwise with gentle shaking, until in excess

This test can be used on group 2 metal ions and transition metal ions.

Results for Group 2

The results in this test are an application of the trend that group II hydroxides become **more soluble** down the group.

Magnesium hydroxide is classed as insoluble in water and will appear as a **white precipitate**.

Simplest Ionic Equation for formation of Mg(OH)₂ (s)

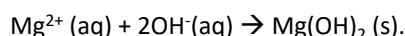

A suspension of magnesium hydroxide in water will appear slightly alkaline (pH 9) so some hydroxide ions must therefore have been produced by a very slight dissolving.

Calcium hydroxide is classed as partially soluble in water and will appear as a **white precipitate** (it may need more sodium hydroxide to be added before it appears compared to a magnesium solution.)

Simplest Ionic Equation for formation of Ca(OH)₂ (s)

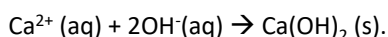

A suspension of calcium hydroxide in water will appear more alkaline (pH 11) than magnesium hydroxide as it is more soluble so there will be more hydroxide ions present in solution.

Strontium and **barium** salts will not form a hydroxide precipitate on addition of sodium hydroxide due to their high solubility. The solutions will be highly alkaline

Results for Group 3

Aluminium salts will form a white precipitate of aluminium hydroxide which will dissolve in excess sodium hydroxide to form a colourless solution

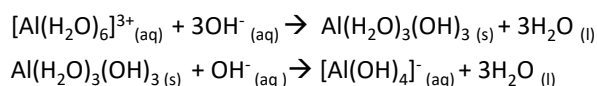

Results for transition metals

Copper solutions form a blue ppt,
iron (II) solutions form a green ppt
iron (III) solutions form a brown ppt

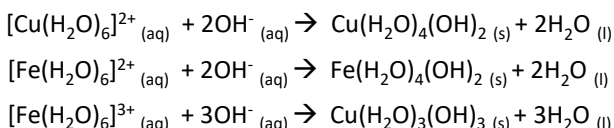

Testing for Ammonium ions (NH₄⁺)

- Place about 10 drops of 0.1 mol dm⁻³ ammonium chloride in a test tube.
- Add about 10 drops of 0.4 mol dm⁻³ sodium hydroxide solution. Shake the mixture.
- Warm the mixture in the test tube gently using a water bath.
- Test the fumes released from the mixture by holding a piece of damp red litmus paper in the mouth of the test tube.

Results: alkaline ammonia gas is released which turns the red litmus paper blue

Method: adding sulfate ions

- Place about 10 drops of 0.1 mol dm⁻³ metal ion solution in a test tube.
- Add about 10 drops of 1.0 mol dm⁻³ sulfuric acid (or other soluble sulfate solution.
- Continue to add sulfuric acid solution, dropwise with gentle shaking, until in excess

The results in this test are an application of the trend that Group II sulfates become **less soluble** down the group

magnesium and **calcium** salts will not form a sulfate precipitate on addition of sulfate ions due to their high solubility.

Strontium and barium solutions will form white precipitates with addition of sulfate ions

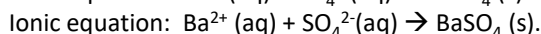
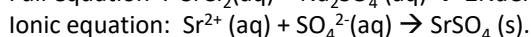
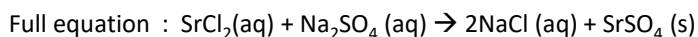

Required activity 4: Testing for anions: – Group 7 (halide ions), OH⁻, CO₃²⁻, SO₄²⁻

Testing for presence of a sulfate ion

BaCl₂ solution acidified with hydrochloric acid is used as a reagent to test for sulphate ions.

If acidified **Barium Chloride** is added to a solution that contains sulfate ions a **white precipitate** of Barium Sulfate forms.

Simplest ionic equation

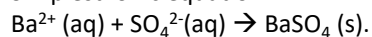

Other anions should give a negative result which is no precipitate forming.



The hydrochloric acid is needed to react with carbonate impurities that are often found in salts which would form a white Barium carbonate precipitate and so give a false result. You could not use sulphuric acid because it contains sulphate ions and so would give a false positive result.

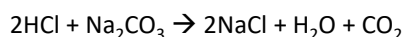

Fizzing due to CO₂ would be observed if a carbonate was present.

Testing for presence of halide ions with silver nitrate.

This reaction is used as a test to identify which halide ion is present. The test solution is made acidic with **nitric acid**, and then **Silver nitrate solution** is added dropwise.

Fluorides produce no precipitate

Chlorides produce a **white precipitate**

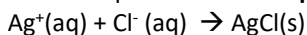

Bromides produce a **cream precipitate**

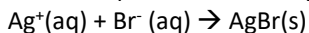

Iodides produce a **pale yellow precipitate**

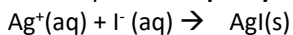

The role of nitric acid is to react with any carbonates present to prevent formation of the precipitate Ag₂CO₃. This would mask the desired observations

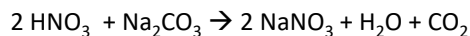

The silver halide precipitates can be treated with ammonia solution to help differentiate between them if the colours look similar:

Silver chloride dissolves in **dilute ammonia** to form a complex ion



Silver bromide dissolves in **concentrated ammonia** to form a complex ion

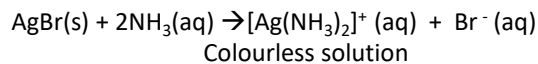

Silver iodide does not react with ammonia – it is too insoluble.

Testing for presence of carbonate ions

Add any dilute acid and observe effervescence.

Bubble gas through limewater to test for CO₂ – will turn limewater cloudy

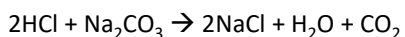

Fizzing due to CO₂ would be observed if a carbonate was present

Testing for presence of a hydroxide ions

Alkaline hydroxide ions will turn red litmus paper blue

Reactions of halide salts with concentrated sulphuric acid.

The Halides show increasing power as reducing agents as one goes down the group. This can be clearly demonstrated in the various reactions of the solid halides with concentrated sulphuric acid.

Know the equations and observations of these reactions very well.

Explanation of differing reducing power of halides

A reducing agent donates electrons.
The reducing power of the halides increases down group 7
They have a greater tendency to donate electrons.
This is because as the ions get bigger it is easier for the outer electrons to be given away as the pull from the nucleus on them becomes smaller.

Fluoride and Chloride

F⁻ and Cl⁻ ions are not strong enough reducing agents to reduce the S in H₂SO₄. No redox reactions occur. Only acid-base reactions occur.

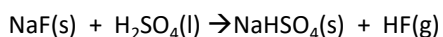

Observations: White steamy fumes of HF are evolved.

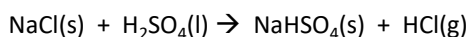

Observations: White steamy fumes of HCl are evolved.

These are acid-base reactions and not redox reactions. H₂SO₄ plays the role of an acid (proton donor).

Bromide

Br⁻ ions are stronger reducing agents than Cl⁻ and F⁻ and after the initial acid-base reaction reduce the Sulphur in H₂SO₄ from +6 to +4 in SO₂

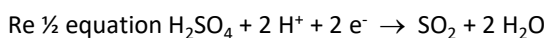
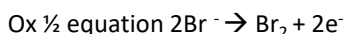
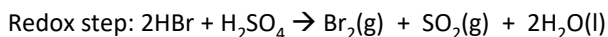
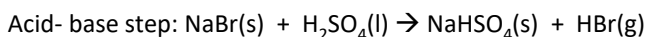

Observations: White steamy fumes of HBr are evolved.

Red fumes of Bromine are also evolved and a colourless, acidic gas SO₂

Reduction product = sulphur dioxide

Note the H₂SO₄ plays the role of acid in the first step producing HBr and then acts as an oxidising agent in the second redox step.

Iodide

I⁻ ions are the strongest halide reducing agents. They can reduce the Sulphur from +6 in H₂SO₄ to +4 in SO₂, to 0 in S and -2 in H₂S.

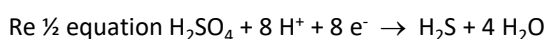
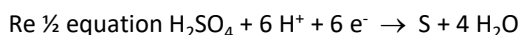
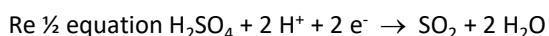
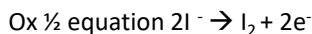
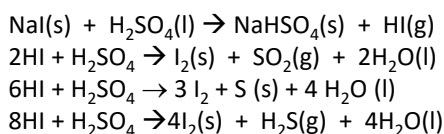

Observations:

White **steamy fumes** of HI are evolved.

Black solid and **purple fumes** of Iodine are also evolved

A **colourless, acidic gas** SO₂

A **yellow solid** of Sulphur

H₂S (Hydrogen Sulphide), a **gas** with a **bad egg smell**,

Reduction products = sulphur dioxide, sulphur and hydrogen sulphide

Note the H₂SO₄ plays the role of acid in the first step producing HI and then acts as an oxidising agent in the three redox steps

Often in exam questions these redox reactions are worked out after first making the half-equations

More on Insoluble salts and Precipitation reactions

Insoluble salts can be made by mixing appropriate solutions of ions so that a **precipitate** is formed
 Barium nitrate (aq) + sodium sulfate (aq) → **Barium Sulfate (s)** + sodium nitrate (aq)
 These are called **precipitation** reactions. A **precipitate is a solid**

There are some common rules for solubility of salts. No syllabus requires these to be learnt but a good chemist does know them.

Soluble salts	Insoluble salts
All sodium, potassium and ammonium salts	
All nitrates	
Most chlorides, bromides, iodides	Silver, lead chlorides, bromides iodides
Most sulfates	Lead sulfate strontium and barium sulfate
Sodium, potassium and ammonium carbonates	Most other carbonates
Sodium, potassium and ammonium hydroxides	Most other hydroxides

When making an insoluble salt, normally the salt would be removed by **filtration**, washed with **distilled water to remove soluble impurities** and then **dried on filter paper**

Filtration

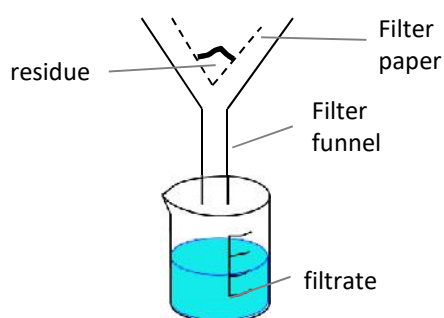

This is gravitational filtration. Use if small amounts of solid are formed.

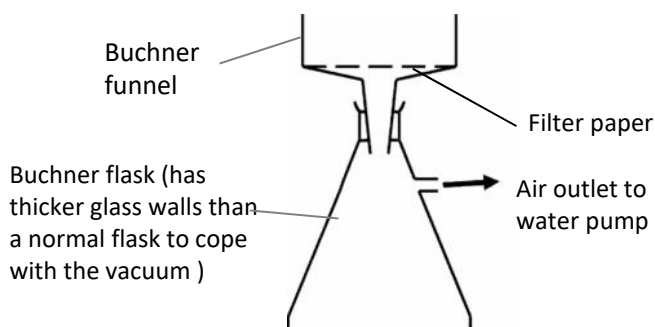

This is vacuum filtration. The apparatus is connected to a water pump which will produce a vacuum. Use if larger amounts of solid are formed.

For both types of filtration apparatus AQA expect filter paper to be drawn on the diagram

Writing Ionic equations for precipitation reactions

We usually write ionic equations to show precipitation reactions. Ionic equations only show the ions that are reacting and leave out spectator ions.

Spectator ions are ions that are

- Not changing state
- Not changing oxidation number

Take full equation

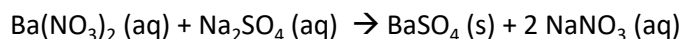

Separate (aq) solutions into ions

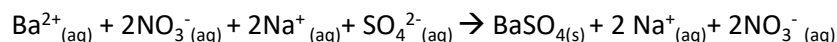

Cancel out spectator ions leaving the simplest ionic equation

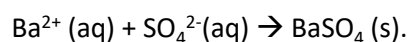

Required practical 5. Distillation of a product from a reaction

Partial Oxidation of Primary Alcohols

Reaction: primary alcohol \rightarrow aldehyde

Reagent: potassium dichromate (VI) solution and dilute sulphuric acid.

Conditions: (use a limited amount of dichromate) warm gently and **distil** out the aldehyde as it forms:

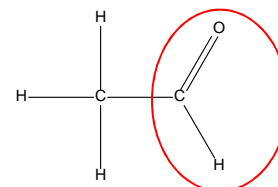

Ethanal

Observation: the orange dichromate ion ($\text{Cr}_2\text{O}_7^{2-}$) reduces to the green Cr^{3+} ion

SAFETY

You must wear gloves when handling solid potassium dichromate(VI) since it is highly toxic and a category 2 carcinogen; it is also an irritant. Avoid inhaling any dust. Concentrated sulphuric acid is corrosive.

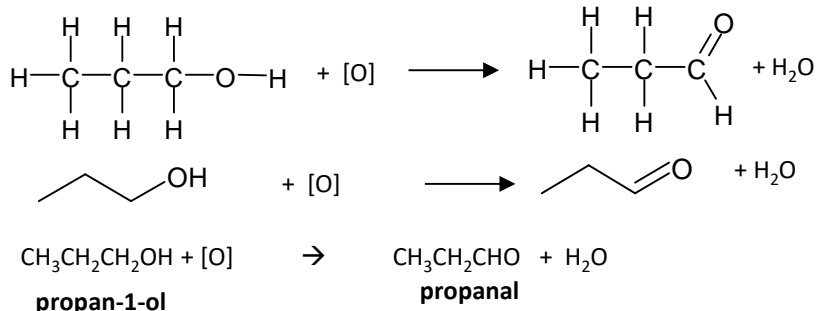

Detailed Method: The partial oxidation of propan-1-ol

This experiment uses a limited quantity of oxidising agent (0.01 mol) and the product is distilled from the reaction mixture immediately it is formed. In this way we hope to achieve a partial oxidation of propan-1-ol.

- Place about 10 cm³ of dilute sulphuric acid in a flask and add about 3g of potassium dichromate(VI) and 2 or 3 anti-bumping granules. Shake the contents of the flask until solution is complete (do not warm).
- Add 1.5 cm³ of propan-1-ol in drops from a dropping pipette, shaking the flask so as to mix the contents, and then assemble distillation apparatus as shown below
- Gently heat and slowly distil 2 cm³ of liquid into a test tube, taking care that none of the reaction mixture splashes over.

Distillation

In general used as separation technique to separate an organic product from its reacting mixture. Need to collect the distillate of the approximate boiling point range of the desired liquid.

Note the bulb of the thermometer should be at the T junction connecting to the condenser to measure the correct boiling point

Note the water goes in the bottom of the condenser to go against gravity. This allows more efficient cooling and prevents back flow of water.

Electric heaters are often used to heat organic chemicals. This is because organic chemicals are normally highly flammable and could set on fire with a naked flame.

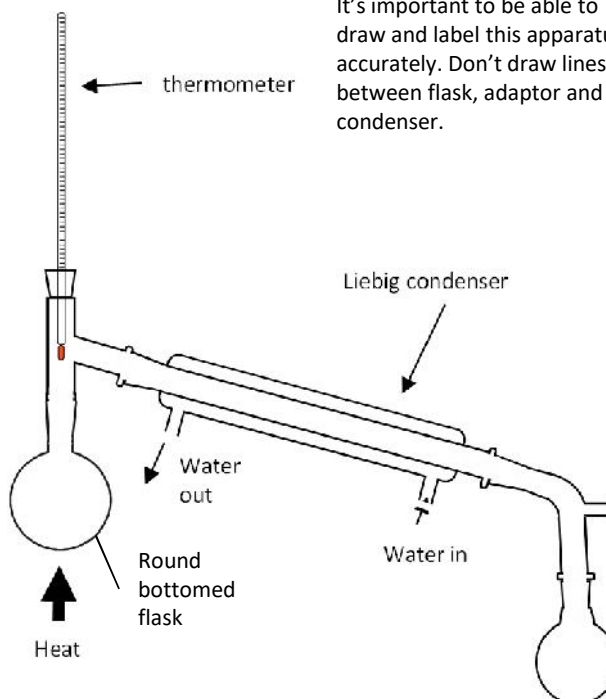

It's important to be able to draw and label this apparatus accurately. Don't draw lines between flask, adaptor and condenser.

Fractional Distillation: In the laboratory

- Heat the flask, with a Bunsen burner or electric mantle
- This causes vapours of all the components in the mixture to be produced.
- Vapours pass up the fractionating column.
- The vapour of the substance with the lower boiling point reaches the top of the fractionating column first.
- The thermometer should be at or below the boiling point of the most volatile substance.
- The vapours with higher boiling points condense back into the flask.
- Only the most volatile vapour passes into the condenser.
- The condenser cools the vapours and condenses to a liquid and is collected.

Fractional distillation is used to separate liquids with different boiling points

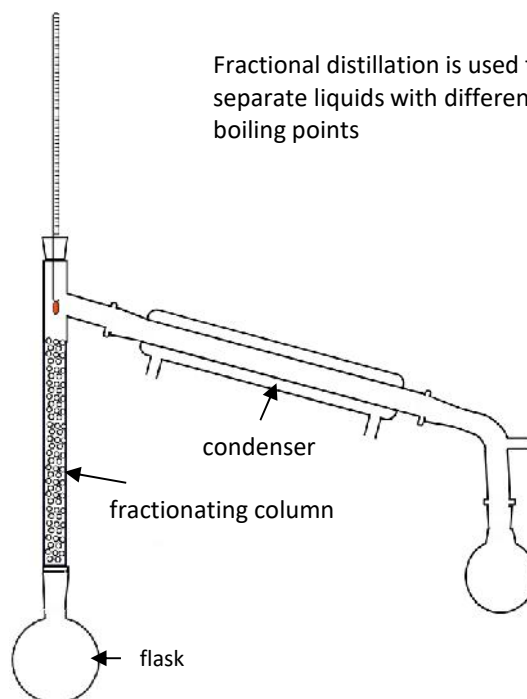

Required activity 6. Tests for alcohol, aldehyde, alkene and carboxylic acid

Functional group test for an Alkene

To 0.5 cm³ of bromine water in a test tube add a few drops of the unknown and shake.

Observation: alkenes should decolourise bromine water

Functional group tests for an Aldehyde

Tollen's Reagent

Reagent: Tollen's Reagent formed by mixing aqueous ammonia and silver nitrate. The active substance is the complex ion of $[\text{Ag}(\text{NH}_3)_2]^+$.

Conditions: heat gently

Reaction: aldehydes only are oxidised by Tollen's reagent into a carboxylic acid and the silver(I) ions are reduced to silver atoms

Observation: with aldehydes, a silver mirror forms coating the inside of the test tube. Ketones result in no change.

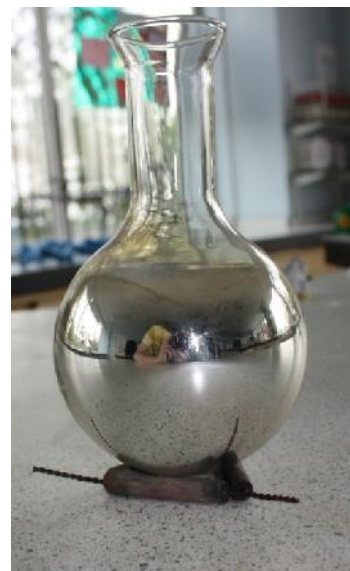
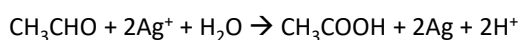

Tollen's reagent method

Place 1 cm³ of silver nitrate solution in each of two clean boiling tubes. Then add one drop of sodium hydroxide solution to form a precipitate of silver oxide. Add ammonia solution dropwise until a clear, colourless solution is formed. Add a few drops of the unknown and leave in the water bath for a few minutes.

Fehling's solution

Reagent: Fehling's Solution containing blue Cu^{2+} ions.

Conditions: heat gently

Reaction: aldehydes only are oxidised by Fehling's Solution into a carboxylic acid and the copper (II) ions are reduced to copper(I) oxide.

Observation: Aldehydes: Blue Cu^{2+} ions in solution change to a red precipitate of Cu_2O . **Ketones do not react**

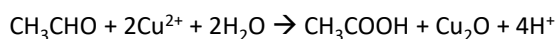

Fehling's solution method

Place 1 cm³ of Fehling's A into each of two boiling tubes, and then add Fehling's B until the blue precipitate redissolves. Add a few drops of the unknown and leave in the water bath for a few minutes.

Functional group test for a Carboxylic acid

To 0.5 cm³ of your unknown solution in a test tube add a small amount of sodium carbonate solid and observe.

Result carboxylic acids will fizz with sodium carbonate due to CO_2 produced

The presence of a carboxylic acid can be tested by addition of **sodium carbonate**. It will fizz and produce carbon dioxide

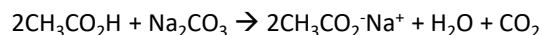

Testing for halogenoalkanes method

- Arrange three test tubes in a row and add three drops of halogenoalkane in the sequence 1-chlorobutane, 1-bromobutane, 1-iodobutane.
- Add 4 cm³ of 0.02 M silver nitrate to each halogenoalkane.
- Without delay, put all three test tubes simultaneously in a hot water bath.
- Note the order in which precipitates appear

Comparing the rate of hydrolysis of halogenoalkanes reaction

Hydrolysis is defined as the splitting of a molecule (in this case a haloalkane) by a reaction with water



Aqueous silver nitrate is added to a haloalkane and the halide leaving group combines with a silver ion to form a **SILVER HALIDE PRECIPITATE**.

The precipitate only forms when the halide ion has left the haloalkane and so the rate of formation of the precipitate can be used to compare the reactivity of the different haloalkanes.

Water is a **poor nucleophile** but it can react **slowly** with haloalkanes in a substitution reaction

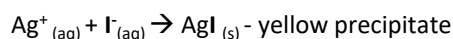

The iodoalkane forms a precipitate with the silver nitrate first as the C-I bond is weakest and so it hydrolyses the quickest

The **quicker** the **precipitate** is formed, the **faster** the **substitution** reaction and the **more reactive** the haloalkane

The rate of these substitution reactions depends on the strength of the C-X bond . The weaker the bond, the easier it is to break and the faster the reaction.

$\text{AgI}_{(\text{s})}$ - yellow precipitate

$\text{AgBr}_{(\text{s})}$ - cream precipitate

$\text{AgCl}_{(\text{s})}$ - white precipitate

↑ forms faster

Summary of Identification of Functional Groups by test-tube reactions

Functional group	Reagent	Result
Alkene	Bromine water	Orange colour decolourises
Aldehyde	Fehling's solution	Blue solution to red precipitate
Aldehyde	Tollen's Reagent	Silver mirror formed
Carboxylic acid	Sodium carbonate solution	Effervescence of CO ₂ evolved
1° 2° alcohol and aldehyde	Sodium dichromate and sulphuric acid	Orange to green colour change
chloroalkane	Warm with silver nitrate	Slow formation of white precipitate of AgCl
Acyl chloride	Silver nitrate (room temperature)	Vigorous reaction- steamy fumes of HCl- rapid white precipitate of AgCl

Required activity 7 measuring the rate of reaction: by an initial rate method

The initial rate can be calculated from taking the gradient of a continuous monitoring conc vs time graph at time = zero

Initial rate can also be calculated from clock reactions where the time taken to reach a fixed concentration is measured.

A Common Clock Reaction (no need to learn details)

Hydrogen peroxide reacts with iodide ions to form iodine. The thiosulfate ion then immediately reacts with iodine formed in the second reaction as shown below.

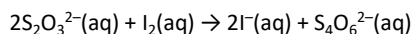
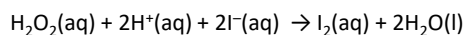

When the I_2 produced has reacted with all of the limited amount of thiosulfate ions present, excess I_2 remains in solution. Reaction with the starch then suddenly forms a dark blue-black colour.

A series of experiments is carried out, in which the concentration of iodide ions is varied, while keeping the concentrations of all of the other reagents the same. In each experiment the time taken (t) for the reaction mixture to turn blue is measured.

In clock reactions there are often two successive reactions and an end point is achieved when one limited reactant runs out, resulting in a sudden colour change

By repeating the experiment several times, varying the concentration of a reactant e.g. I^- , (keeping the other reactants at constant concentration) you can determine the order of reaction with respect to that reactant

The initial rate of the reaction can be represented as $(1/t)$

Detailed method

- Put each of the chemicals in the table in separate burettes.
- In each experiment, measure out required volumes of the potassium iodide, sodium thiosulphate, starch and water into a small conical flask from the burettes
- Measure the hydrogen peroxide into a test tube
- Pour the hydrogen peroxide from the test tube into the conical flask and immediately start the timer. Stir the mixture.
- Time until the first hint of blue/ black colour appears

Experiment	Sulfuric acid (H^+) ml	Starch ml	Water ml	Potassium iodide(I^-) ml	Sodium Thiosulfate $\text{S}_2\text{O}_3^{2-}$ ml	Hydrogen peroxide ml
1	25	1	20	5	5	10
2	25	1	15	10	5	10
3	25	1	10	15	5	10
4	25	1	5	20	5	10
5	25	1	0	25	5	10

Normally to work out the rate equation we do a series of experiments where the initial concentrations of reactants are changed (one at a time) and measure the initial rate each time.

Working out rate order graphically

In an experiment where the concentration of one of the reagents is changed and the reaction rate measured it is possible to calculate the order graphically

Taking rate equation

$$\text{Rate} = k [\text{I}^-]^n$$

Log both sides of equation

$$\text{Log rate} = \text{log } k + n \text{ log } [\text{Y}]$$

$$Y = c + m x$$

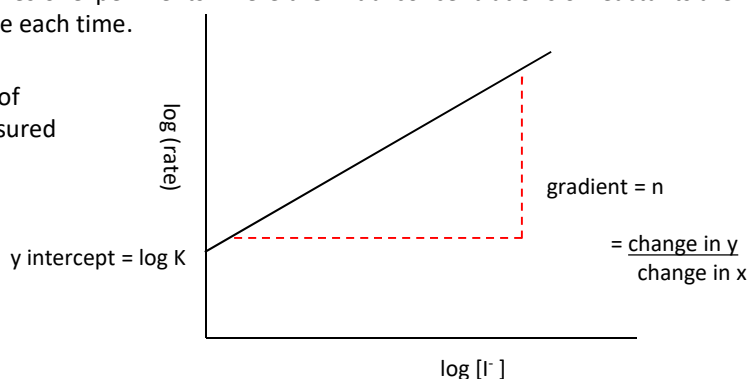

A graph of log rate vs log $[\text{I}^-]$ will yield a straight line where the gradient is equal to the order n

In this experiment high concentrations with quick times will have the biggest percentage errors.

Required activity 7 measuring the rate of reaction: by an continuous monitoring method

When we follow one experiment over time recording the change in concentration it is the continuous rate method.

The gradient represents the rate of reaction. The reaction is fastest at the start where the gradient is steepest. The rate drops as the reactants start to get used up and their concentration drops. The graph will eventually become horizontal and the gradient becomes zero which represents the reaction having stopped.

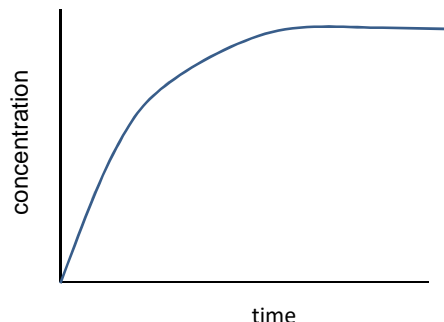

Measurement of the change in volume of a gas

This works if there is a change in the number of moles of gas in the reaction. Using a gas syringe is a common way of following this. It works quite well for measuring continuous rate but a typical gas syringe only measures 100ml of gas so you don't want a reaction to produce more than this volume. Quantities of reactants need to be calculated carefully.

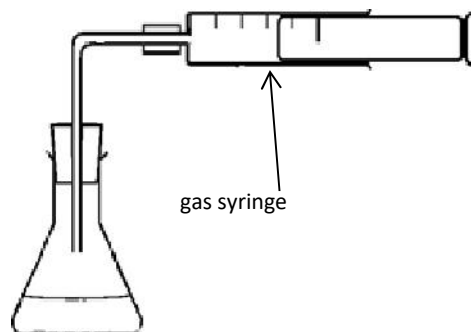
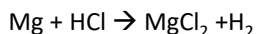

The initial rate is the rate at the start of the reaction, where it is fastest. It is obtained by taking the gradient of a continuous monitoring conc vs time graph at time = zero. A measure of initial rate is preferable as we know the concentrations at the start of the reaction

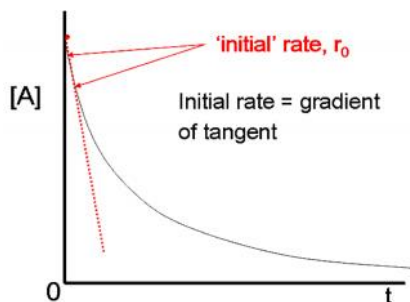

Typical Method

- Measure 50 cm³ of the 1.0 mol dm⁻³ hydrochloric acid and add to conical flask.
- Set up the gas syringe in the stand
- Weigh 0.20 g of magnesium.
- Add the magnesium ribbon to the conical flask, place the bung firmly into the top of the flask and start the timer.
- Record the volume of hydrogen gas collected every 15 seconds for 3 minutes.

Large Excess of reactants

In reactions where there are several reactants, if the concentration of one of the reactant is kept in a large excess then that reactant will appear not to affect rate and will be pseudo-zero order. This is because its concentration stays virtually constant and does not affect rate.

Techniques to investigate rates of reaction

There are several different methods for measuring reactions rates. Some reactions can be measured in several ways

measurement of the change in volume of a gas

This works if there is a change in the number of moles of gas in the reaction. Using a gas syringe is a common way of following this.

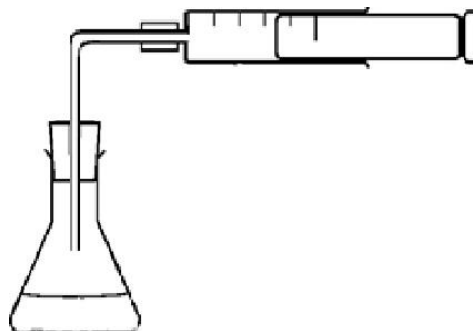
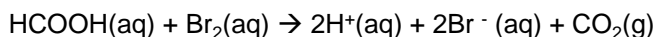
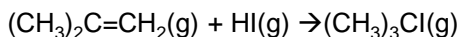

Measurement of change of mass

This works if there is a gas produced which is allowed to escape. Works better with heavy gases such as CO_2

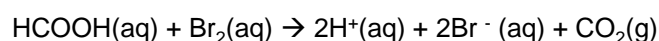

Titrating samples of reaction mixture with acid, alkali, sodium thiosulphate etc

Small samples are removed from the reaction mixture, quenched (which stops the reaction) and the titrated with a suitable reagent.

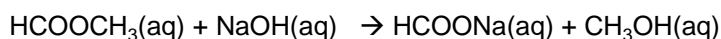

The NaOH could be titrated with an acid

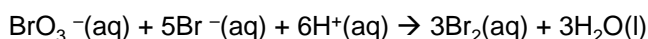

The H^+ could be titrated with an alkali

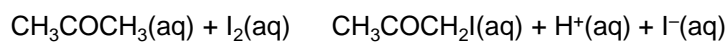

The I_2 could be titrated with sodium thiosulphate

Colorimetry.

If one of the reactants or products is coloured then colorimetry can be used to measure the change in colour of the reacting mixtures

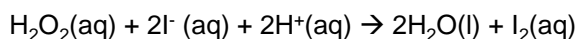

The I_2 produced is a brown solution

Measuring change in electrical conductivity

Can be used if there is a change in the number of ions in the reaction mixture

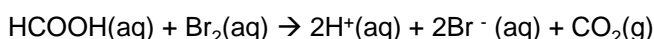

Measurement of optical activity.

If there is a change in the optical activity through the reaction this could be followed in a polarimeter

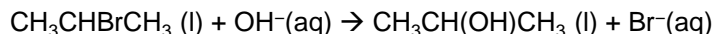

Required activity 8. Measuring the EMF of an electrochemical cell

Method

- Clean the zinc and copper foils with emery before use. Degrease the metal using some cotton wool and propanone.
- Place the copper strip into a 100 cm³ beaker with about 50 cm³ of 1 mol dm⁻³ CuSO₄ solution.
- Place the zinc strip into a 100 cm³ beaker with about 50 cm³ of 1 mol dm⁻³ ZnSO₄ solution.
- Use a strip of filter paper soaked in saturated potassium nitrate solution for the salt bridge
- Connect the Cu(s)|Cu²⁺(aq) and Zn(s)|Zn²⁺(aq) half-cells by connecting the metals using the crocodile clips and leads provided to the voltmeter

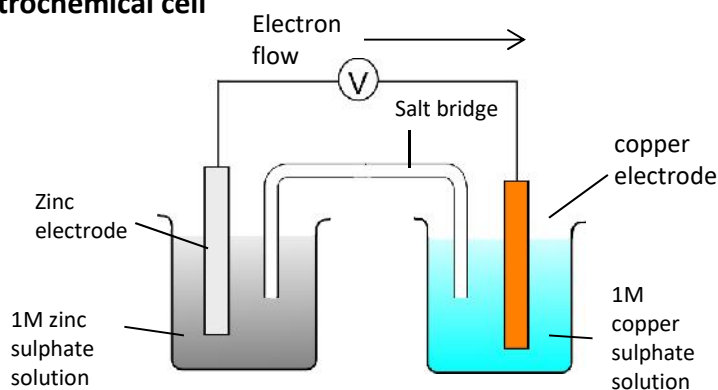

Salt Bridge

The salt bridge is used to connect up the circuit. The **free moving ions** conduct the charge.

A salt bridge is usually made from a piece of filter paper (or material) soaked in a salt solution, usually **Potassium Nitrate**. It can also be a glass U tube containing a salt solution plugged with cotton wool

The salt should be **unreactive with the electrodes and electrode solutions**. E.g. potassium chloride would not be suitable for copper systems because chloride ions can form complexes with copper ions.

A wire is not used because the metal wire would set up its own electrode system with the solutions.

Method

If one or both of the half cells do not contain a conducting metal, we must use an inert platinum electrode.

Set up a copper half cell using a similar arrangement to the previous one. Combine it with a Fe²⁺/Fe³⁺ half-cell with a platinum electrode.

The half cell should have a mixture of acidified 1.0M iron(II) sulphate solution and an equal volume of 0.5M iron(III) sulphate solution as the electrolyte. Use a fresh salt bridge.

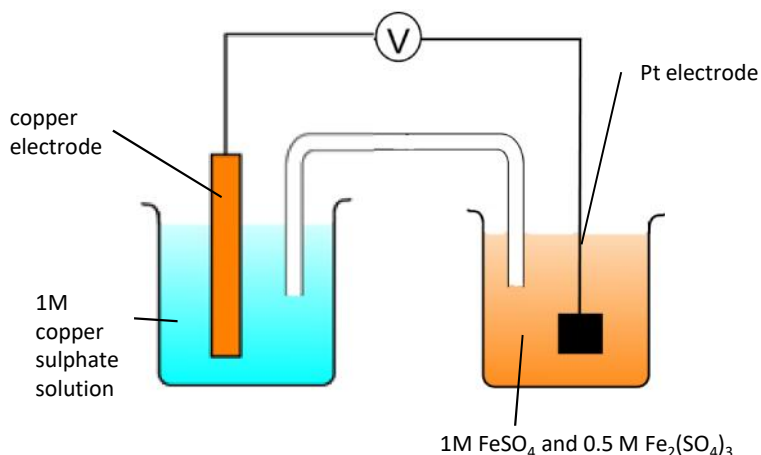

A platinum electrode is used because it is unreactive and can conduct electricity

Note: in the electrode system containing two solutions it is necessary to use a platinum electrode and **both** ion solutions must be of a 1M concentration so [Fe²⁺] = 1M and [Fe³⁺] = 1M .

Required activity 9: Titration curves

Constructing a pH curve

1. Transfer 25cm³ of acid to a conical flask with a volumetric pipette
2. Measure initial pH of the acid with a pH meter
3. Add alkali in small amounts (2cm³) noting the volume added
4. Stir mixture to equalise the pH
5. Measure and record the pH to 1 d.p.
6. Repeat steps 3-5 but when approaching endpoint add in smaller volumes of alkali
7. Add until alkali in excess

Calibrate meter first by measuring known pH of a buffer solution. This is necessary because pH meters can lose accuracy on storage. Most pH probes are calibrated by putting probe in a set buffer (often pH 4) and pressing a calibration button/setting for that pH. Sometimes this is repeated with a second buffer at a different pH

Can also improve accuracy by **maintaining** constant temperature

Strong acid – Strong base

e.g. HCl and NaOH

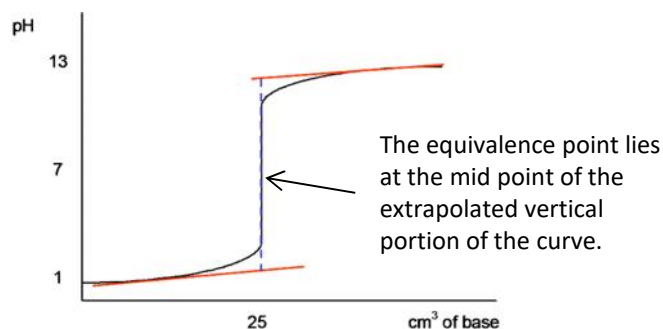
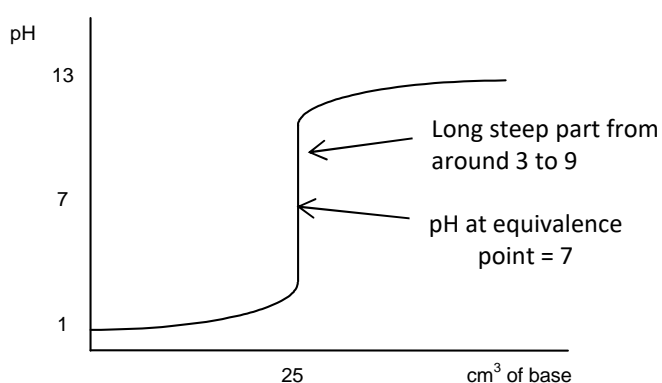

Weak acid – Strong base

e.g. CH₃CO₂H and NaOH

At the start the pH rises quickly and then levels off. The flattened part is called the **buffer region** and is formed because a buffer solution is made

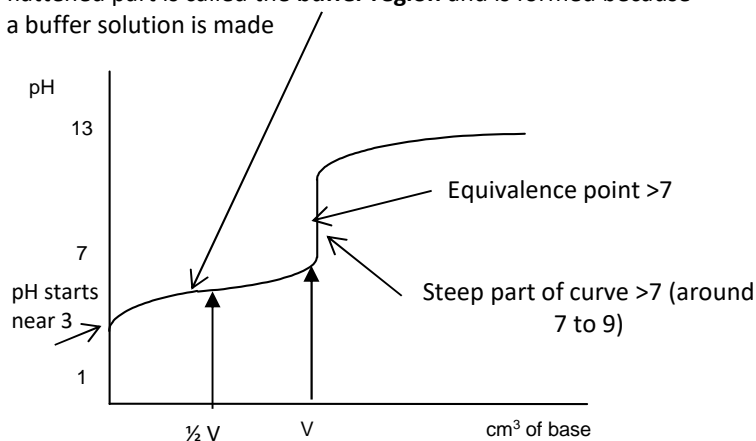

Half neutralisation volume

For weak acids

$$K_a = \frac{[H^+_{(aq)}][A^-_{(aq)}]}{[HA_{(aq)}]}$$

At ½ the neutralisation volume the [HA] = [A⁻]

$$\text{So } K_a = [H^+] \text{ and } pK_a = pH$$

If we know the K_a we can then work out the pH at ½ V or vice versa.

If a pH curve is plotted then the pH of a weak acid at half neutralisation (½ V) will equal the pK_a

Strong acid – Weak base

e.g. HCl and NH₃

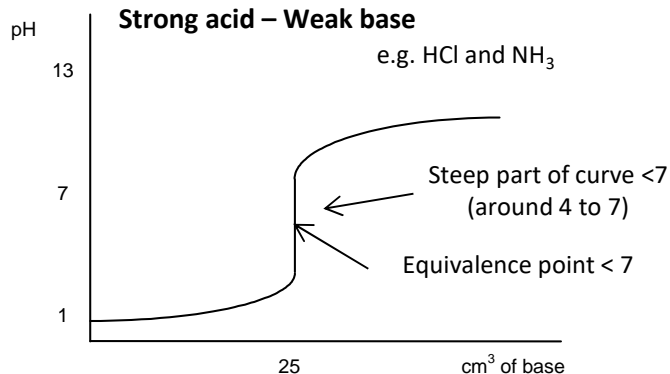

Weak acid – Weak base

e.g. CH₃CO₂H and NH₃

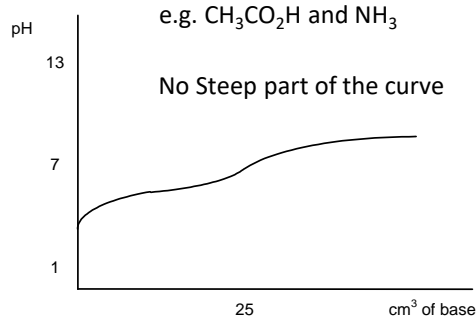

Required activity 10. Preparation of a pure organic solid and test of its purity

Purifying an organic solid: Recrystallisation

Used for purifying aspirin

Step	Reason
1. Dissolve the impure compound in a minimum volume of hot (near boiling) solvent .	An appropriate solvent is one which will dissolve both compound and impurities when hot and one in which the compound itself does not dissolve well when cold. The minimum volume is used to obtain saturated solution and to enable crystallisation on cooling
2. Hot filter solution through (fluted) filter paper quickly.	This step will remove any insoluble impurities and heat will prevent crystals reforming during filtration
3. Cool the filtered solution by inserting beaker in ice	Crystals will reform but soluble impurities will remain in solution form because they are present in small quantities so solution is not saturated. Ice will increase the yield of crystals
4. Suction filtrate with a Buchner flask to separate out crystals	The water pump connected to the Buchner flask reduces the pressure and speeds up the filtration.
5 Wash the crystals with distilled water	To remove soluble impurities
6. Dry the crystals between absorbent paper	

Loss of yield in this process

- Crystals lost when filtering or washing
- Some product stays in solution after recrystallisation
- other side reactions occurring

If the crystals are not dried properly the mass will be larger than expected which can lead to a percentage yield >100%

buchner flask

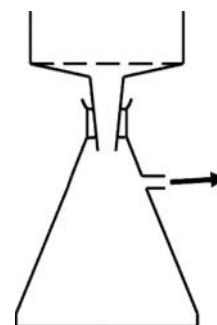

Required activity 10. Preparation of a pure organic solid and test of its purity

Detailed method for Preparation of Aspirin

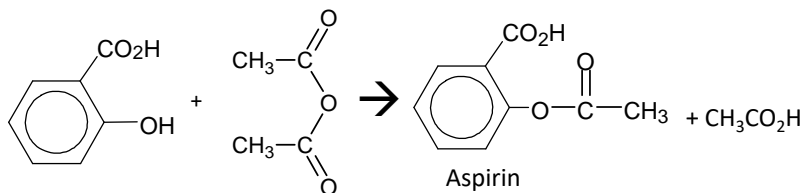

Add to a 50 cm³ pear-shaped flask 2.0 g of 2-hydroxybenzoic acid and 4 cm³ of ethanoic anhydride.

To this mixture add 5 drops of 85% phosphoric(v) acid and swirl to mix, Fit the flask with a **reflux condenser** and heat the mixture on a boiling water bath for about 5 minutes. Without cooling the mixture, carefully add 2 **cm³ of water** in one portion down the condenser.

When the vigorous reaction has ended, pour the mixture into 40 cm³ of cold water in a 100 cm³ beaker, stir and rub the sides of the beaker with a stirring rod necessary to induce crystallisation and, finally, allow the mixture to stand in ice bath to complete crystallisation. Collect the product by suction filtration and wash it with a little water.

Purification stage: recrystallisation

Using a measuring cylinder, measure out 15 cm³ of ethanol into a boiling tube.

Prepare a beaker half-filled with hot water from a kettle at a temperature of approximately 75 °C.

Use a spatula to add the crude aspirin to the boiling tube with ethanol and place the tube in the beaker of hot water.

Stir the contents of the boiling tube until all of the aspirin dissolves into the ethanol.

Pour the hot solution containing dissolved aspirin through a **warmed filter funnel and fluted filter** paper to hot filter

Then pour filtrate into 40 cm³ of water in a conical flask.

Allow the conical flask to cool slowly and white needles of aspirin should separate.

Cool the whole mixture in an ice bath.

Filter off the purified solid under reduced pressure and allow it to dry on filter paper.

Record the mass of the dry purified solid

Aspirin is made from 2-hydroxybenzoic acid which contains a phenol group. In the reaction the phenol group is turned into an ester by reacting it with the reactive ethanoic anhydride

Ethanoic anhydride is used instead of acid chlorides because it is cheaper, less corrosive, less vulnerable to hydrolysis, and less dangerous to use.

The excess ethanoic anhydride will hydrolyse and the contents of the flask will boil.

Avoid naked flames due to flammability of ethanol

This step will remove any insoluble impurities and heat will prevent crystals reforming during filtration

Soluble impurities will remain in solution form because they are present in small quantities so solution is not saturated. Ice will increase the yield of crystals

Detailed method for Nitration Procedure

Measure 2.5 cm³ of methyl benzoate into a small conical flask and then dissolve it in 5 cm³ of concentrated sulfuric acid. When the liquid has dissolved, cool the mixture in ice.

Prepare the nitrating mixture by adding **drop by drop** 2 cm³ of concentrated sulfuric acid to 2 cm³ of concentrated nitric acid. **Cool this mixture in ice** as well.

Now add the nitrating mixture drop by drop from a dropping pipette to the solution of methyl benzoate. Stir the mixture with a thermometer and keep the temperature **below 10 °C**. When the addition is complete, allow the mixture to stand at room temperature for another 15 minutes.

After this time, pour the reaction mixture on to about 25 g of crushed ice and stir until all the ice has melted and crystalline methyl 3-nitrobenzoate has formed.

Then use same purification method as in aspirin above

Conc acids are corrosive- wear gloves

The acids react together to make the NO₂⁺ ion

This reaction is exothermic so acids are kept cool and acid is added dropwise

The temperature is kept low at this stage to prevent multiple substitution of nitro groups on the benzene ring

Measuring melting point

One way of testing for the degree of purity is to determine the melting "point", or melting range, of the sample.

If the sample is very pure then the melting point will be a sharp one, at the same value as quoted in data books.

If **impurities** are present (and this can include solvent from the recrystallisation process) the **melting point will be lowered** and the sample will **melt over a range** of several degrees Celsius

Melting point can be measured in an electronic melting point machine or by using a practical set up where the capillary tube is strapped to a thermometer immersed in some heating oil.

In both cases a small amount of the sample is put into a capillary tube. The tube is heated up and is **heated slowly near the melting point**

Comparing an experimentally determined melting point value with one quoted in a data source will verify the degree of purity.

Sometimes an error may occur if the temperature on the thermometer is not the same as the temperature in the actual sample tube.

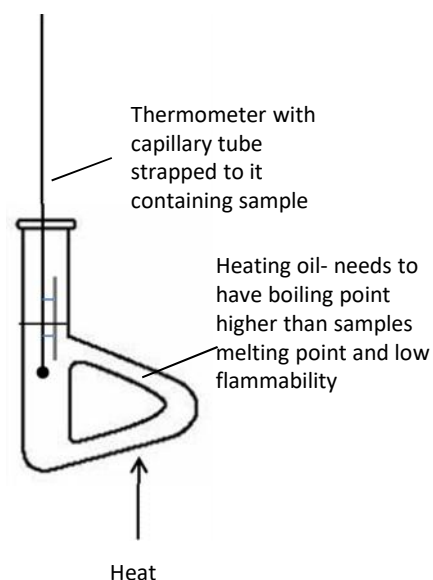

Required activity 10. Preparation of a pure organic liquid

Purifying an organic liquid

General method

- Put the distillate of impure product into a separating funnel
- wash product by adding either
 - sodium hydrogencarbonate solution, shaking and releasing the pressure from CO₂ produced.
 - Saturated sodium chloride solution
- Allow the layers to separate in the funnel, and then run and discard the aqueous layer.
- Run the organic layer into a clean, dry conical flask and add three spatula loads of drying agent (e.g. anhydrous sodium sulphate, calcium chloride) to dry the organic liquid. When dry the organic liquid should appear clear.
- Carefully decant the liquid into the distillation flask
- Distill to collect pure product

Sodium hydrogencarbonate will neutralise any remaining reactant acid.

Sodium chloride will help separate the organic layer from the aqueous layer

The layer with lower density will be the upper layer. This is usually the organic layer

The drying agent should

- be insoluble in the organic liquid
- not react with the organic liquid

Decant means carefully pour off organic liquid leaving the drying agent in the conical flask

Separating funnel



Detailed method for preparing and purifying Cyclohexene from cyclohexanol

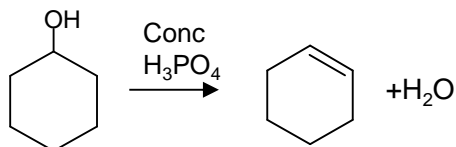

- Pour about 20 cm³ of cyclohexanol into a weighed 50 cm³ pear-shaped flask. Reweigh the flask and record the mass of cyclohexanol.
- Using a plastic graduated dropping pipette, carefully and with frequent shaking, add to the flask approximately 8 cm³ of concentrated phosphoric acid.
- Add a few anti-bumping granules to the flask and assemble the distillation apparatus, so that the contents of the flask may be distilled. Heat the flask gently, distilling over any liquid which boils below 100 °C.
- Pour the distillate into a separating funnel and add 50 cm³ of saturated sodium chloride solution. Shake the mixture and allow the two layers to separate.
- run off the lower layer into a beaker and then transfer the upper layer, which contains the crude cyclohexene, into a small conical flask.
- Add a few lumps of anhydrous calcium chloride or anhydrous sodium sulfate(VI) or anhydrous magnesium sulfate to the crude cyclohexene to remove water. Stopper the flask, shake the contents and allow this to stand until the liquid becomes clear.
- Decant the liquid into a clean, dry, weighed sample container.
- Reweigh the container, calculate the mass of dry cyclohexene produced

Detailed Method for Preparing and Purifying an Ester

Propyl ethanoate can be made in the laboratory from propan-1-ol and ethanoic acid.

The equation for the reaction is

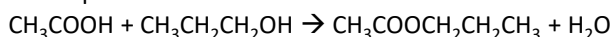

Procedure

1. Propan-1-ol (50 cm³) and ethanoic acid (50 cm³) are mixed thoroughly in a 250 cm³ round-bottomed flask.
2. **Concentrated sulfuric acid** (10 cm³) is added **drop by drop to the mixture**, keeping the contents of the flask well-shaken and **cooled** in an ice-water bath.
3. When the acid has all been added, a **reflux condenser** is fitted to the flask and the mixture gently boiled over an **electric heating mantle** for about **30 minutes**.
4. The mixture is cooled, and the apparatus rearranged for distillation. The crude ester (about 60 cm³) is distilled off.
5. The distillate is placed in a separating funnel and shaken with about half its volume of **30% sodium carbonate** solution, with the **pressure being released at intervals**. The **lower aqueous layer is then discarded**.
6. The crude ester is shaken in a separating funnel with about half its volume of 50% calcium chloride solution, which removes unreacted alcohol. The lower layer is discarded.
7. The ester is run into a clean, dry flask containing **some anhydrous calcium chloride** and swirled.
8. The ester is filtered into a clean, dry flask, with a **few anti-bumping granules**, and distilled. The fraction boiling between 100°C and 103°C is collected.

Sulfuric acid is a catalyst

Adding conc H₂SO₄ is an exothermic reaction- to prevent uncontrolled boiling over add **drop by drop** and **cool**

In **reflux** the reactant vapours of volatile compound are condensed and returned to the reaction mixture. The reaction is slow so it is heated for **30 minutes** **The electric heating mantle** allows for controlled heating and stops flammable vapour lighting

Sodium carbonate reacts with unreacted acid and remaining catalyst still present after distillation.

The reaction produces CO₂ so the **pressure** of gas needs to be **released**.

The upper layer is organic because it has a lower density than water

Calcium chloride is a drying agent. The liquid will appear clear when dry.

Anti-bumping granules are added to prevent vigorous, uneven boiling by making small bubbles form instead of large bubbles

Measuring boiling point

Purity of liquid can be determined by measuring a boiling point. This can be done in a distillation set up or by simply boiling a tube of the sample in an heating oil bath. If the liquid is pure it will have the boiling point referred to in data books. If impure the boiling point tends to be higher than the pure liquid

Pressure should be noted as changing pressure can change the boiling point of a liquid

Measuring boiling point is not the most accurate method of identifying a substance as several substances may have the same boiling point.

To get a correct measure of boiling point the thermometer should be above the level of the surface of the boiling liquid and be measuring the temperature of the saturated vapour.

Required activity 11: Testing aqueous transition metal ions

Method sodium hydroxide

- Place about 10 drops of metal ion solution in a test tube.
- Add sodium hydroxide solution, dropwise with gentle shaking, until in excess.

Method ammonia solution

- Place about 10 drops of metal ion solution in a test tube.
- Add ammonia solution, dropwise with gentle shaking, until in excess.

Reaction with limited OH⁻ and limited NH₃

The bases OH⁻ and ammonia when in limited amounts form the same hydroxide precipitates. They form in **deprotonation acid base reactions**

M(OH)₂(H₂O)₄(s) : Cu blue ppt, Fe (II) green ppt
M(OH)₃(H₂O)₃(s) : Fe(III) brown ppt, Al white ppt

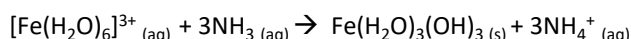
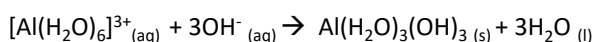
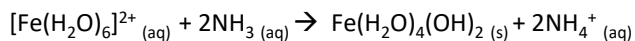
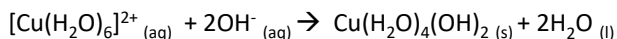

This process can happen step wise removing one proton at a time. Be able to write equations for this too.

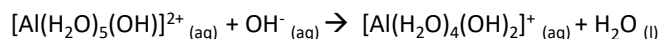
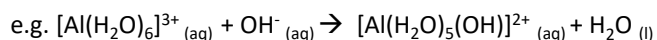

Here the NH₃ and OH⁻ ions are acting as **Bronsted-Lowry bases** accepting a proton

Reaction with excess OH⁻

With excess NaOH the Al hydroxide dissolves. Al becomes [Al(OH)₄]⁻(aq) colourless solution.

This hydroxides is classed as **amphoteric** because it reacts and dissolves in both acids and bases.

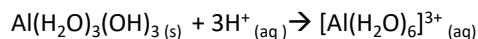
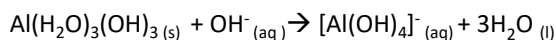

Reaction with excess NH₃

With **excess NH₃** a **ligand substitution** reaction occurs with Cu and its precipitate dissolve

This substitution is incomplete with Cu.

Cu becomes [Cu(NH₃)₄(H₂O)₂]²⁺ deep blue solution

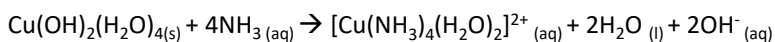

In this reactions NH₃ is acting as a **Lewis base** donating an electron pair.

Method sodium carbonate

- Place about 10 drops of sodium carbonate solution in a test tube.
- Add about 10 drops of metal ions solution and shake the mixture gently.

Reactions with Carbonate solution

The 2+ ions react differently to the 3+ ions with carbonate solutions.

The **2+** ions with **carbonate** solution results in **MCO₃ ppt** being formed (Cu blue/green, Fe(II) green)

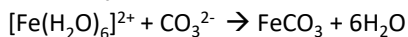
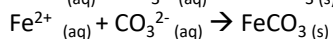
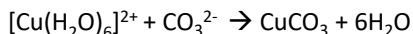
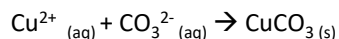

These are **precipitation** reactions

The **3+** ions with **carbonate** solution form a **M(OH)₃ ppt** and **CO₂** gas is evolved.

Al forms white ppt of Al(OH)₃(H₂O)₃ + CO₂

Fe(III) forms brown ppt of Fe(OH)₃(H₂O)₃ + CO₂

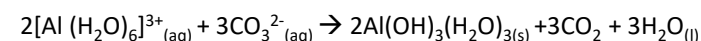
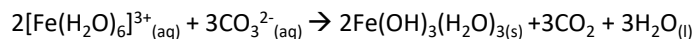

MCO₃ is formed with 2+ ions but M₂(CO₃)₃ is not formed with 3+ ions. The difference is explained by the greater polarising power of the 3+ ion due to its higher charge density.

These are classed as **acidity reactions**.

Required activity 12. Separation of species by thin-layer chromatography

Method: Thin-layer chromatography

- Wearing gloves**, draw a **pencil line** 1 cm above the bottom of a TLC plate and mark spots for each sample, equally spaced along line.
- Use a capillary tube to add a **tiny drop** of each solution to a different spot and allow the plate to air dry.
- Add solvent to a chamber or large beaker with a lid so that is no more than **1cm in depth**
- Place the TLC plate into the chamber, **making sure that the level of the solvent is below the pencil line**. Replace the lid to get a **tight seal**.
- When the level of the solvent **reaches about 1 cm from the top of the plate**, remove the plate and mark the solvent level with a pencil. Allow the plate to **dry in the fume cupboard**.
- Place the plate under a **UV lamp** in order to see the spots. Draw around them lightly in pencil.
- Calculate the R_f values of the observed spots.

Wear plastic gloves to prevent contamination from the hands to the plate

pencil line –will not dissolve in the solvent

tiny drop – too big a drop will cause different spots to merge

Depth of solvent– if the solvent is too deep it will dissolve the sample spots from the plate

lid– to prevent evaporation of toxic solvent

Will get more accurate results if the solvent is allowed to rise to near the top of the plate but the R_f value can be calculated if the solvent front does not reach the top of the plate

dry in a **fume** cupboard as the solvent is toxic

UV lamp used if the spots are colourless and not visible

$$R_f \text{ value} = \frac{\text{distance moved by amino acid}}{\text{distance moved by the solvent}}$$

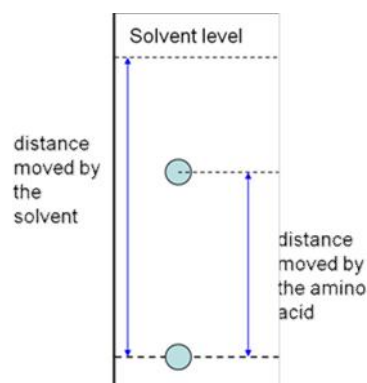

Separation by chromatography depends on the balance between solubility in the moving phase and retention in the stationary phase.

A solid stationary phase separates by adsorption,
A liquid stationary phase separates by relative solubility

If the stationary phase was polar and the moving phase was non-polar e.g. Hexane. Then non-polar compounds would pass through the plate more quickly than polar compounds as they would have a greater solubility in the non-polar moving phase. (Think about intermolecular forces)

R_f values are used to identify different substances.

Practical: Working out equilibrium constant Kc

A common experiment is working out the equilibrium constant for an esterification reaction. Ethanol and ethanoic acid are mixed together with a sulphuric acid catalyst.

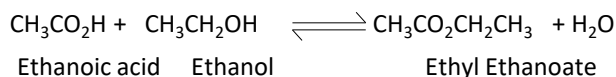

Method

Part 1 Preparing the equilibrium mixture

- 1 Use burettes to prepare a mixture in boiling tube of carboxylic acid, alcohol, and dilute sulfuric acid.
- 2 Swirl and bung tube. Leave the mixture to reach equilibrium for one week

Part 2 Titrating the equilibrium mixture

- 1 Rinse a 250 cm³ volumetric flask with distilled water. Use a funnel to transfer the contents of the boiling tube into the flask. Rinse the boiling tube with water and add the washings to the volumetric flask.
- 2 Use distilled water to make up the solution in the volumetric flask to exactly 250 cm³. Stopper the flask, then invert and shake the contents thoroughly.
- 3 Use the pipette to transfer 25.0 cm³ of the diluted equilibrium mixture to a 250 cm³ conical flask.
- 4 Add 3 or 4 drops of phenolphthalein indicator to the conical flask.
- 5 Set up the burette with sodium hydroxide solution..
- 6 Add the sodium hydroxide solution from the burette until the mixture in the conical flask just turns pink. Record this burette reading in your table.
- 7 Repeat the titration until you obtain a minimum of two concordant titres.

The sodium hydroxide will react with the sulphuric acid catalyst and any unreacted carboxylic acid in the equilibrium mixture

There are many different calculations that can be based on this experiment. Let's look at general stages. Not all calculations will use all the stages.

Working out initial amount of moles of reactants

The amount of moles of alcohol and carboxylic acid can be calculated from the densities and volumes of liquids added

Mass = density x volume

then

Moles = mass X Mr

The initial amount of moles of acid catalyst used is usually determined by titrating a separate sample of catalyst with sodium hydroxide

Working out equilibrium amount of moles of acid present from the titre results

39.0 cm³ of 0.400 mol dm⁻³ sodium hydroxide was used in the above titration. The initial moles of sulphuric acid was 5x10⁻⁴ mol. Calculate the moles of ethanoic acid present at equilibrium

Amount of NaOH = vol X conc
= 0.039 x 0.400
= 0.0156 mol

So total amount of H⁺ present in 25cm³ = 0.0156 mol

So total amount of H⁺ present in 250cm³ = 0.156 mol

Total mol acid present = moles of carboxylic acid + moles of acid catalyst

So

Amount of carboxylic acid at equilibrium = 0.156 - (5x10⁻⁴ x 2)
= 0.155 mol

X 2 because H₂SO₄
has 2 H⁺

The pink colour of the phenolphthalein in the titration can fade after the end-point of the titration has been reached because the addition of sodium hydroxide may make the equilibrium shift towards the reactants

Working out equilibrium amount of moles of other substances

Calculate the equilibrium amount of ethanol, ethyl ethanoate and water if there were initially 0.400 mol of ethanol and 0.500 mol of ethanoic acid and at equilibrium there were 0.155 mol of ethanoic acid.

Amount of ethanoic acid that reacted = initial amount – equilibrium amount
= 0.5 – 0.155
= 0.344 mol

Amount of ethanol at equilibrium = initial amount - amount that reacted
= 0.400 – 0.344
= 0.056 mol

Amount of ethyl ethanoate at equilibrium = initial amount + amount that formed
= 0 + 0.344
= 0.344 mol

Amount of water at equilibrium = initial amount + amount that formed
= 0 + 0.344
= 0.344 mol

The amount of water at equilibrium would not really be 0 as there would be water present in the acid catalyst

Calculating the equilibrium constant

Finally calculate the equilibrium constant.

To work out equilibrium concentrations divide the equilibrium amounts by the total volume. Then put in Kc expression

$$K_c = \frac{[\text{CH}_3\text{CO}_2\text{CH}_2\text{CH}_3] [\text{H}_2\text{O}]}{[\text{CH}_3\text{CO}_2\text{H}] [\text{CH}_3\text{CH}_2\text{OH}]}$$

In order to confirm that one week was sufficient time for equilibrium to be established in the mixture from Part 1, several mixtures could be made and left for different amount of time. If the resulting Kc is the same value then it can be concluded the time is sufficient

Spectrophotometry

If visible light of increasing frequency is passed through a sample of a coloured complex ion, some of the light is absorbed.

The amount of light absorbed is proportional to the concentration of the absorbing species (and to the distance travelled through the solution).

Some complexes have only pale colours and do not absorb light strongly. In these cases a suitable ligand is added to intensify the colour.

Absorption of visible light is used in spectrometry to determine the concentration of coloured ions.

method

- Add an appropriate ligand to intensify colour
- Make up solutions of known concentration
- Measure absorption or transmission
- Plot graph of absorption vs concentration
- Measure absorption of unknown and compare

Spectrometers contain a coloured filter. The colour of the filter is chosen to only allow the wavelengths of light through that would be most strongly absorbed by the coloured solution.

Detailed method- measuring absorption of copper solutions

- Take nine 100cm³ graduated flasks and pipette 20cm³ of 2M ammonia solution into each one.
- Use the 0.05M solution of aqueous copper sulphate to make up solutions which are 0.005 to 0.04M [Cu(NH₃)₆]²⁺
- Mix each solution thoroughly.
- Insert the red filter into the colorimeter.
- Use a cuvette with distilled water to zero the colorimeter
- Then put each prepared solution in cuvette and measure the absorbance of each solution.
- Plot graph of absorption vs concentration
- Measure absorption of unknown solution and determine its concentration from the calibration curve

Autocatalytic Reaction between Ethanedioate and Manganate ions

Potassium manganate(VII) will oxidise ethanedioic acid (oxalic acid) to carbon dioxide and water, in the presence of an excess of acid:

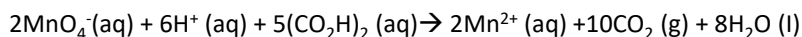

Detailed method

1. Prepare a reaction mixture according to the table, using measuring cylinders.
2. Some members of your group should use Mixture 1 and some Mixture 2. The results should then be shared.
3. Add 50 cm³ of 0.02 M potassium manganate(VII) and start timing. Shake the mixture for about half a minute to mix it well.
4. After about a minute use a pipette to withdraw a 10.0 cm³ portion of the reaction mixture and empty into a conical flask.
5. Note the time and add about 10cm³ of 0.1 M potassium iodide solution. This stops the reaction and releases iodine equivalent to the remaining manganate(VII) ions.
6. Titrate the liberated iodine with 0.01 M sodium thiosulphate, adding a little starch solution near the end-point Record the titre of sodium thiosulphate.
7. Remove further portions every 3 or 4 minutes and titrate them in the same way. Continue until the titre is less than 3 cm³,

Solution	Mixture 1	Mixture 2
0.2 M ethanedioic acid	100cm ³	100cm ³
0.2 M manganese(II) sulphate	--	15cm ³
1 M sulphuric acid	10 cm ³	10cm ³
Water	90 cm ³	75 cm ³

Explanation of results

The autocatalysis by Mn²⁺ in titrations of C₂O₄²⁻ with MnO₄⁻

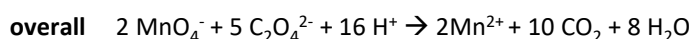

Catalysed alternative route

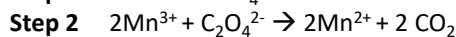
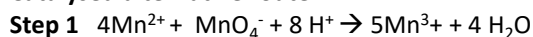

The initial uncatalysed reaction is **slow** because the reaction is a collision between **two negative ions** which **repel each other** leading to a **high activation energy**.

The Mn²⁺ ions produced act as an **autocatalyst** and therefore the reaction starts to speed up because they bring about the alternative reaction route with lower activation energy.

The reaction eventually slows as the **MnO₄⁻ concentration drops**.

This is an example of **autocatalysis** where one of the products of the reaction can catalyse the reaction.

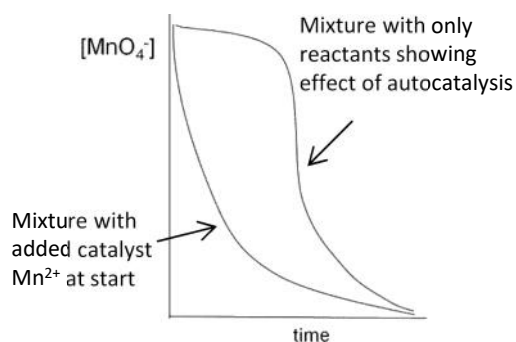

Alternative method for following the reaction rate

This experiment can be done by removing samples at set times and titrating to work out the concentration of MnO₄⁻. It could also be done by use of a spectrometer measuring the intensity of the purple colour. This method has the advantage that it **does not disrupt the reaction mixture**, using up the reactants and it leads to a much **quicker determination of concentration**.