

## 1.2 Calculations

The mole is the key concept for chemical calculations

DEFINITION: **The mole** is the amount of substance in grams that has the same number of particles as there are atoms in 12 grams of carbon-12.

DEFINITION: **Relative atomic mass** is the **average mass** of one atom compared to one twelfth of the mass of one atom of carbon-12

DEFINITION: **Relative molecular mass** is the **average mass** of a molecule compared to one twelfth of the mass of one atom of carbon-12

### Avogadro's Number

There are  $6.022 \times 10^{23}$  atoms in 12 grams of carbon-12.

Therefore explained in simpler terms 'One mole of any specified entity contains  $6.022 \times 10^{23}$  of that entity':

For most calculations we will do at A-level we will use the following 3 equations to work out moles

Learn these equations carefully and what units to use in them.

| 1. For pure solids, liquids and gases                                     | 2. For gases                                                                                               | 3. For solutions                                                                                                                                                                      |
|---------------------------------------------------------------------------|------------------------------------------------------------------------------------------------------------|---------------------------------------------------------------------------------------------------------------------------------------------------------------------------------------|
| $\text{moles} = \frac{\text{mass}}{M_r}$                                  | $PV = nRT$                                                                                                 | $\text{Concentration} = \frac{\text{moles}}{\text{volume}}$                                                                                                                           |
| Unit of Mass: grams<br>Unit of moles : mol                                | Unit of Pressure (P):Pa<br>Unit of Volume (V): $\text{m}^3$<br>Unit of Temp (T): K<br>n= moles<br>R = 8.31 | Unit of concentration: $\text{mol dm}^{-3}$ or M<br>Unit of Volume: $\text{dm}^3$                                                                                                     |
| <b>Remember the <math>M_r</math> must be calculated and quoted to 1dp</b> | <b>Converting temperature</b><br>$^{\circ}\text{C} \rightarrow \text{K add } 273$                          | <b>Converting volumes</b><br>$\text{cm}^3 \rightarrow \text{dm}^3 \div 1000$<br>$\text{cm}^3 \rightarrow \text{m}^3 \div 1000\ 000$<br>$\text{dm}^3 \rightarrow \text{m}^3 \div 1000$ |

### Using Equation 1

#### 1. For pure solids, liquids and gases

$$\text{moles} = \frac{\text{mass}}{M_r}$$

Unit of Mass: grams  
Unit of moles : mol

**Example 1:** What is the number of moles in 35.0g of  $\text{CuSO}_4$ ?

$$\begin{aligned} \text{moles} &= \text{mass}/M_r \\ &= 35.0 / (63.5 + 32.0 + 16.0 \times 4) \\ &= 0.219 \text{ mol} \end{aligned}$$

#### Significant Figures

Give your answers to the same number of significant figures as the number of significant figures for the data you given in a question. If you are given a mixture of different significant figures, use the smallest

Molar Mass ( $M_r$ ) for a compound can be calculated by adding up the mass numbers(from the periodic table) of each element in the compound  
eg  $\text{CaCO}_3 = 40.1 + 12.0 + 16.0 \times 3 = 100.1$

Many questions will involve changes of units  
 $1000 \text{ mg} = 1\text{g}$   
 $1000 \text{ g} = 1\text{kg}$   
 $1000\text{kg} = 1 \text{ tonne}$

**Example 2:** What is the number of moles in 75.0mg of  $\text{CaSO}_4 \cdot 2\text{H}_2\text{O}$ ?

$$\begin{aligned} \text{moles} &= \text{mass}/M_r \\ &= 0.075 / (40 + 32.0 + 16.0 \times 4 + 18.0 \times 2) \\ &= 4.36 \times 10^{-4} \text{ mol} \end{aligned}$$

## Avogadro's Constant

**The mole** is the amount of substance in grams that has the same number of particles as there are atoms in 12 grams of carbon-12.

### Avogadro's Constant (L)

There are  $6.022 \times 10^{23}$  atoms in 12 grams of carbon-12. Therefore explained in simpler terms 'One mole of any specified entity contains  $6.022 \times 10^{23}$  of that entity':

Avogadro's Constant can be used for atoms, molecules and ions

1 mole of copper atoms will contain  $6.022 \times 10^{23}$  atoms  
1 mole of carbon dioxide molecules will contain  $6.022 \times 10^{23}$  molecules  
1 mole of sodium ions will contain  $6.022 \times 10^{23}$  ions

**No of particles = moles of substance (in mol) X Avogadro's constant**

**Example 3** : How many atoms of Tin are there in a 6.00 g sample of Tin metal?

$$\begin{aligned}\text{moles} &= \text{mass}/A_r \\ &= 6.00/118.7 \\ &= 0.05055 \text{ mol} \\ \text{Number atoms} &= \text{moles} \times 6.022 \times 10^{23} \\ &= 0.05055 \times 6.022 \times 10^{23} \\ &= 3.04 \times 10^{22}\end{aligned}$$

**Example 4** : How many chloride ions are there in a 25.0 cm<sup>3</sup> of a solution of magnesium chloride of concentration 0.400 mol dm<sup>-3</sup> ?

$$\begin{aligned}\text{moles} &= \text{concentration} \times \text{Volume} \\ \text{MgCl}_2 &= 0.400 \times \mathbf{0.0250} \\ &= 0.0100 \text{ mol} \\ \text{moles of chloride ions} &= 0.0100 \times 2 \\ &= 0.0200 \quad \text{There are two moles of chloride ions for every one mole of MgCl}_2 \\ \text{Number ions of Cl}^- &= \text{moles} \times 6.022 \times 10^{23} \\ &= 0.0200 \times 6.022 \times 10^{23} \\ &= 1.20 \times 10^{22} \text{ (to 3 sig fig)}\end{aligned}$$

## Density

Density calculations are usually used with pure liquids but to work out the mass from a measured volume. It can also be used with solids and gases.

$$\text{density} = \frac{\text{mass}}{\text{Volume}}$$

Density is usually given in g cm<sup>-3</sup>  
Care needs to be taken if different units are used.

**Example 5** : How many molecules of ethanol are there in a 0.500 dm<sup>3</sup> of ethanol (CH<sub>3</sub>CH<sub>2</sub>OH) liquid ? The density of ethanol is 0.789 g cm<sup>-3</sup>

$$\begin{aligned}\text{Mass} &= \text{density} \times \text{Volume} \\ \text{ethanol} &= 0.789 \times 500 \\ &= 394.5\text{g} \\ \text{moles} &= \text{mass}/M_r \\ &= 394.5/46.0 \\ &= 8.576 \text{ mol} \\ \text{Number of molecules} &= \text{moles} \times 6.022 \times 10^{23} \\ &= 8.576 \times 6.022 \times 10^{23} \\ &= 5.16 \times 10^{23} \text{ (to 3 sig fig)}\end{aligned}$$

**Example 6** : There are 980mol of pure gold in a bar measuring 10 cm by 20 cm by 50 cm. What is the density of gold in kg dm<sup>-3</sup>

$$\begin{aligned}\text{Mass} &= \text{moles} \times M_r \\ &= 980 \times 197 \\ &= 193060 \text{ g} \\ &= 193.06\text{kg} \\ \text{Volume} &= 10 \times 20 \times 50 \\ &= 10\,000\text{cm}^3 \\ &= 10\text{dm}^3 \\ \text{density} &= \text{mass}/\text{volume} \\ &= 193/10 \\ &= 19.3 \text{ kg dm}^{-3}\end{aligned}$$

## Empirical formulae

**Definition:** An empirical formula is the **simplest** ratio of atoms of each **element** in the compound.

### General method

Step 1 : Divide each mass (or % mass) by the atomic mass of the element

Step 2 : For each of the answers from step 1 divide by the smallest one of those numbers.

Step 3: sometimes the numbers calculated in step 2 will need to be multiplied up to give whole numbers.

These whole numbers will be the empirical formula.

The same method can be used for the following types of data:

1. masses of each element in the compound
2. percentage mass of each element in the compound

**Example 7 :** Calculate the empirical formula for a compound that contains 1.82g of K, 5.93g of I and 2.24g of O

Step1: Divide each mass by the atomic mass of the element to give moles

$$\begin{array}{lll} \text{K} = 1.82 / 39.1 & \text{I} = 5.93/126.9 & \text{O} = 2.24/16 \\ = 0.0465 \text{ mol} & = 0.0467\text{mol} & = 0.14\text{mol} \end{array}$$

Step 2 For each of the answers from step 1 divide by the smallest one of those numbers.

$$\begin{array}{lll} \text{K} = 0.0465/0.0465 & \text{I} = 0.0467/0.0465 & \text{O} = 0.14 / 0.0465 \\ = 1 & = 1 & = 3 \end{array}$$

Empirical formula =KIO<sub>3</sub>

### Molecular formula from empirical formula

**Definition:** A molecular formula is the **actual** number of atoms of each element in the compound.

From the relative molecular mass (Mr) work out how many times the mass of the empirical formula fits into the Mr.

**Example 8 :** work out the molecular formula for the compound with an empirical formula of C<sub>3</sub>H<sub>6</sub>O and a M<sub>r</sub> of 116

C<sub>3</sub>H<sub>6</sub>O has a mass of 58

The empirical formula fits twice into M<sub>r</sub> of 116

So molecular formula is C<sub>6</sub>H<sub>12</sub>O<sub>2</sub>

Remember the Mr of a substance can be found out from using a mass spectrometer. The molecular ion ( the peak with highest m/z) will be equal to the Mr.

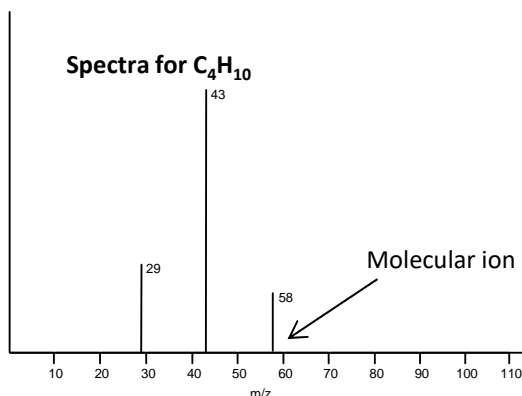

The Mr does not need to be exact to turn an empirical formula into the molecular formula because the molecular formula will be a whole number multiple of the empirical formula

## Hydrated salt

A Hydrated salt contains water of crystallisation

$\text{Cu}(\text{NO}_3)_2 \cdot 6\text{H}_2\text{O}$   
hydrated copper (II) nitrate(V).

$\text{Cu}(\text{NO}_3)_2$   
Anhydrous copper (II) nitrate(V).

### Example 9

$\text{Na}_2\text{SO}_4 \cdot x\text{H}_2\text{O}$  has a molar mass of 322.1, Calculate the value of x

$$\text{Molar mass } x\text{H}_2\text{O} = 322.1 - (23 \times 2 + 32.1 + 16 \times 4) \\ = 180$$

$$X = 180/18 \\ = 10$$

## Heating in a crucible

This method could be used for measuring mass loss in various thermal decomposition reactions and also for mass gain when reacting magnesium in oxygen.

The water of crystallisation in calcium sulphate crystals can be removed as water vapour by heating as shown in the following equation.

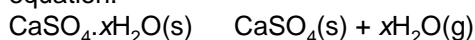

### Method.

- Weigh an empty clean dry crucible and lid .
- Add 2g of hydrated calcium sulphate to the crucible and weigh again
- Heat strongly with a Bunsen for a couple of minutes
- Allow to cool
- Weigh the crucible and contents again
- Heat crucible again and reweigh until you reach a constant mass ( do this to ensure reaction is complete).

Large amounts of hydrated calcium sulphate, such as 50g, should not be used in this experiment as the decomposition is likely to be incomplete.

The crucible needs to be dry otherwise a wet crucible would give an inaccurate result. It would cause mass loss to be too large as the water would be lost when heating.

The lid improves the accuracy of the experiment as it prevents loss of solid from the crucible but should be loose fitting to allow gas to escape.

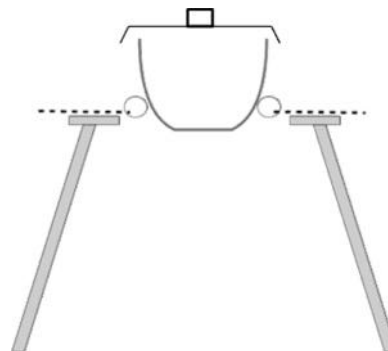

Small amounts of the solid, such as 0.100 g, should **not** be used in this experiment as the percentage uncertainties in weighing will be too high.

**Example 10.** 3.51 g of hydrated zinc sulphate were heated and 1.97 g of anhydrous zinc sulphate were obtained.

Use these data to calculate the value of the integer x in  $\text{ZnSO}_4 \cdot x\text{H}_2\text{O}$

Calculate the mass of  $\text{H}_2\text{O} = 3.51 - 1.97 = 1.54\text{g}$

|                                    |                        |                                         |                     |
|------------------------------------|------------------------|-----------------------------------------|---------------------|
| Calculate moles of $\text{ZnSO}_4$ | $= \frac{1.97}{161.5}$ | Calculate moles of $\text{H}_2\text{O}$ | $= \frac{1.54}{18}$ |
|                                    | $= 0.0122$             |                                         | $= 0.085$           |

|                                                                    |                           |  |                          |
|--------------------------------------------------------------------|---------------------------|--|--------------------------|
| Calculate ratio of mole of $\text{ZnSO}_4$ to $\text{H}_2\text{O}$ | $= \frac{0.0122}{0.0122}$ |  | $= \frac{0.085}{0.0122}$ |
|                                                                    | $= 1$                     |  | $= 7$                    |

$$X = 7$$

## Concentration of Solutions

A solution is a mixture formed when a solute dissolves in a solvent. In chemistry we most commonly use water as the solvent to form aqueous solutions. The solute can be a solid, liquid or a gas.

Molar concentration can be measured for solutions. This is calculated by dividing the amount in moles of the solute by the volume of the solution. The volume is measure is  $\text{dm}^3$ . The unit of molar concentration is  $\text{mol dm}^{-3}$ ; it can also be called molar using symbol M

|                                                             |
|-------------------------------------------------------------|
| $\text{Concentration} = \frac{\text{moles}}{\text{volume}}$ |
|-------------------------------------------------------------|

Unit of concentration:  $\text{mol dm}^{-3}$  or M

Unit of Volume:  $\text{dm}^3$

### Converting volumes

A  $\text{m}^3$  is equivalent to a cube  
 $100\text{cm} \times 100\text{cm} \times 100\text{cm} = 1000000\text{cm}^3$

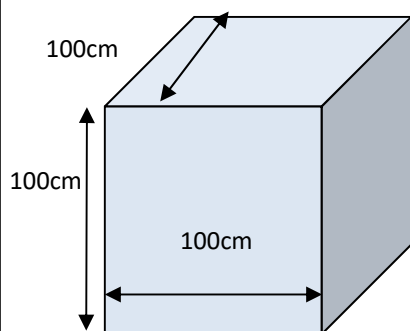

$$1 \text{ m}^3 = 1000 \text{ dm}^3 \text{ or } 1000\text{L}$$

To convert  $\text{m}^3$  into  $\text{dm}^3$  multiply by 1000

|                                                                                                                                                                                       |
|---------------------------------------------------------------------------------------------------------------------------------------------------------------------------------------|
| $\begin{aligned} \text{cm}^3 &\rightarrow \text{dm}^3 \div 1000 \\ \text{cm}^3 &\rightarrow \text{m}^3 \div 1000\ 000 \\ \text{dm}^3 &\rightarrow \text{m}^3 \div 1000 \end{aligned}$ |
|---------------------------------------------------------------------------------------------------------------------------------------------------------------------------------------|

A  $\text{dm}^3$  is equivalent to a cube  
 $10\text{cm} \times 10\text{cm} \times 10\text{cm} = 1000\text{cm}^3$

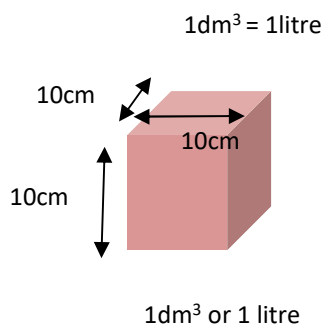

$$1 \text{ dm}^3 = 1000 \text{ cm}^3 \text{ or } 1000\text{mL}$$

To convert  $\text{cm}^3$  into  $\text{dm}^3$  divide by 1000

A  $\text{cm}^3$  is equivalent to a cube  
 $1\text{cm} \times 1\text{cm} \times 1\text{cm}$

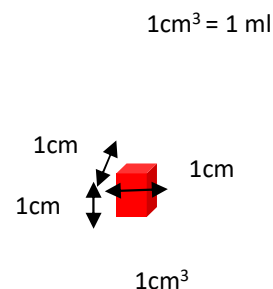

**Example 11** What is the concentration of solution made by dissolving 5.00g of  $\text{Na}_2\text{CO}_3$  in  $250 \text{ cm}^3$  water?

$$\begin{aligned} \text{moles} &= \text{mass}/\text{Mr} \\ &= 5 / (23.0 \times 2 + 12 + 16 \times 3) \\ &= 0.0472 \text{ mol} \\ \text{conc} &= \text{moles}/\text{Volume} \\ &= 0.0472 / 0.25 \\ &= 0.189 \text{ mol dm}^{-3} \end{aligned}$$

**Example 12** What is the concentration of solution made by dissolving 10kg of  $\text{Na}_2\text{CO}_3$  in  $0.50 \text{ m}^3$  water?

$$\begin{aligned} \text{moles} &= \text{mass}/\text{Mr} \\ &= 10\ 000 / (23.0 \times 2 + 12 + 16 \times 3) \\ &= 94.2 \text{ mol} \\ \text{conc} &= \text{moles}/\text{Volume} \\ &= 94.2 / 500 \\ &= 0.19 \text{ mol dm}^{-3} \end{aligned}$$

## Mass Concentration

The concentration of a solution can also be measured in terms of mass of solute per volume of solution

$$\text{Mass Concentration} = \frac{\text{mass}}{\text{volume}}$$

Unit of mass concentration:  $\text{g dm}^{-3}$

Unit of Mass **g**

Unit of Volume:  **$\text{dm}^3$**

To turn concentration measured in  $\text{mol dm}^{-3}$  into concentration measured in  $\text{g dm}^{-3}$  multiply by Mr of the substance

$$\text{conc in g dm}^{-3} = \text{conc in mol dm}^{-3} \times \text{Mr}$$

The concentration in  $\text{g dm}^{-3}$  is the same as the mass of solute dissolved in  $1\text{dm}^3$

## Ions dissociating

When soluble ionic solids dissolve in water they will dissociate into separate ions. This can lead to the concentration of ions differing from the concentration of the solute.

### Example 13

If 5.86g (0.1 mol) of sodium chloride (NaCl) is dissolved in  $1\text{ dm}^3$  of water then the concentration of sodium chloride solution would be  $0.1\text{ mol dm}^{-3}$ .

However the 0.1mol sodium chloride would split up and form 0.1 mol of sodium ions and 0.1 mol of chloride ions. The concentration of sodium ions is therefore  $0.1\text{ mol dm}^{-3}$  and the concentration of chloride ions is also  $0.1\text{ mol dm}^{-3}$

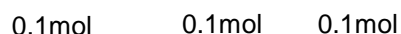
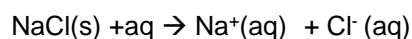

### Example 14

If 9.53g (0.1 mol) of magnesium chloride ( $\text{MgCl}_2$ ) is dissolved in  $1\text{ dm}^3$  of water then the concentration of magnesium chloride solution ( $\text{MgCl}_2\text{ aq}$ ) would be  $0.1\text{ mol dm}^{-3}$ .

However the 0.1mol magnesium chloride would split up and form 0.1 mol of magnesium ions and 0.2 mol of chloride ions. The concentration of magnesium ions is therefore  $0.1\text{ mol dm}^{-3}$  and the concentration of chloride ions is now  $0.2\text{ mol dm}^{-3}$

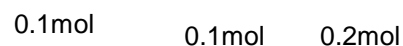

## Making a solution

- Weigh the sample bottle containing the required mass of solid on a 2 dp balance
- Transfer to beaker and reweigh sample bottle
- Record the difference in mass
- Add  $100\text{cm}^3$  of distilled water to the beaker. Use a glass rod to stir to help dissolve the solid.
- Sometimes the substance may not dissolve well in cold water so the beaker and its contents could be heated gently until all the solid had dissolved.
- Pour solution into a  $250\text{cm}^3$  graduated flask via a funnel.
- Rinse beaker and funnel and add washings from the beaker and glass rod to the volumetric flask.
- make up to the mark with distilled water using a dropping pipette for last few drops.
- Invert flask several times to ensure uniform solution.

Alternatively the known mass of solid in the weighing bottle could be transferred to beaker, washed and washings added to the beaker.

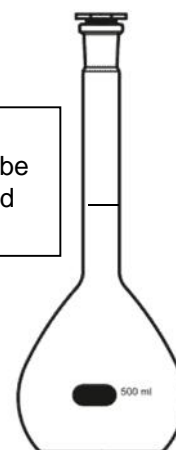

Remember to fill so the bottom of the meniscus sits on the line on the neck of the flask. With dark liquids like potassium manganate it can be difficult to see the meniscus.

## Dilutions

### Diluting a solution

- Pipette 25cm<sup>3</sup> of original solution into a 250cm<sup>3</sup> volumetric flask
- make up to the mark with distilled water using a dropping pipette for last few drops.
- Invert flask several times to ensure uniform solution.

Using a volumetric pipette is more accurate than a measuring cylinder because it has a smaller uncertainty

Use a teat pipette to make up to the mark in volumetric flask to ensure volume of solution accurately measured and one doesn't go over the line

### Calculating Dilutions

Diluting a solution will not change the amount of moles of solute present but increase the volume of solution and hence the concentration will lower

moles= volume x concentration

If amount of moles does not change then

Original volume x original concentration = new diluted volume x new diluted concentration

so

$$\text{new diluted concentration} = \text{original concentration} \times \frac{\text{Original volume}}{\text{new diluted volume}}$$

The new diluted volume will be equal to the original volume of solution added + the volume of water added.

#### Example 15

If 50 cm<sup>3</sup> of water are added to 150 cm<sup>3</sup> of a 0.20 mol dm<sup>-3</sup> NaOH solution, what will the concentration of the diluted solution be?

new diluted concentration = original concentration x  $\frac{\text{Original volume}}{\text{new diluted volume}}$

$$\begin{aligned}\text{new diluted concentration} &= 0.20 \times \frac{0.150}{0.200} \\ &= 0.15 \text{ mol dm}^{-3}\end{aligned}$$

#### Example 16

What volume of water in cm<sup>3</sup> must be added to dilute 5.00 cm<sup>3</sup> of 1.00 mol dm<sup>-3</sup> hydrochloric acid so that it has a concentration of 0.050 mol dm<sup>-3</sup>?

$$\begin{aligned}\text{Moles original solution} &= \text{conc} \times \text{vol} \\ &= 1.00 \times 0.005 \\ &= 0.005\end{aligned}$$

$$\begin{aligned}\text{New volume} &= \text{moles} / \text{conc} \\ &= 0.005 / 0.05 \\ &= 0.1 \text{ dm}^3 = 100 \text{ cm}^3\end{aligned}$$

$$\text{Volume of water added} = 100 - 5 = 95 \text{ cm}^3$$

### Safety and hazards

- Irritant - dilute acid and alkalis- wear goggles
- Corrosive- stronger acids and alkalis wear goggles
- Flammable – keep away from naked flames
- Toxic – wear gloves- avoid skin contact- wash hands after use
- Oxidising- Keep away from flammable / easily oxidised materials

Hazardous substances in low concentrations or amounts will not pose the same risks as the pure substance.

## Ideal Gas Equation

The ideal gas equation applies to all gases and mixtures of gases. If a mixture of gases is used the value  $n$  will be the total moles of all gases in the mixture.

The biggest problems students have with this equation is choosing and converting to the correct units, so pay close attention to the units.

$$PV = nRT$$

Unit of Pressure (P): Pa  
Unit of Volume (V):  $\text{m}^3$   
Unit of Temp (T): K  
 $n$  = moles  
 $R = 8.31 \text{ JK}^{-1}\text{mol}^{-1}$

**Example 17:** What is the mass of  $\text{Cl}_2$  gas that has a pressure of 100kPa, temperature  $20^\circ\text{C}$ , volume  $500\text{cm}^3$ . ( $R = 8.31$ )

$$\text{moles} = PV/RT$$

$$= 100\,000 \times 0.0005 / (8.31 \times 293)$$

$$= 0.0205 \text{ mol}$$

$$\text{Mass} = \text{moles} \times M_r$$

$$= 0.0205 \times (35.5 \times 2)$$

$$= 1.46 \text{ g}$$

$$100 \text{ kPa} = 100\,000 \text{ Pa}$$

$$20^\circ\text{C} = 20 + 273 = 293\text{K}$$

$$500 \text{ cm}^3 = 0.0005 \text{ m}^3$$

### Converting temperature

$$^\circ\text{C} \rightarrow \text{K add } 273$$

**Example 18:** 0.150g of a volatile liquid was injected into a sealed gas syringe. The gas syringe was placed in an oven at  $70^\circ\text{C}$  at a pressure of 100kPa and a volume of  $80\text{cm}^3$  was measured. What is the  $M_r$  of the volatile liquid? ( $R = 8.31$ )

$$\text{moles} = PV/RT$$

$$= 100\,000 \times 0.00008 / (8.31 \times 343)$$

$$= 0.00281 \text{ mol}$$

$$M_r = \text{mass}/\text{moles}$$

$$= 0.15 / 0.00281$$

$$= 53.4 \text{ g mol}^{-1}$$

$$100 \text{ kPa} = 100\,000 \text{ Pa}$$

$$80 \text{ cm}^3 = 0.00008 \text{ m}^3$$

## Using a gas syringe

Gas syringes can be used for a variety of experiments where the volume of a gas is measured, possibly to work out moles of gas or to follow reaction rates.

The volume of a gas depends on pressure and temperature so when recording volume it is important to note down the temperature and pressure of the room.

Moles of gas can be calculated from gas volume (and temperature and pressure) using ideal gas equation  $PV = nRT$

Potential errors in using a gas syringe

- gas escapes before bung inserted
- syringe sticks
- some gases like carbon dioxide or sulphur dioxide are soluble in water so the true amount of gas is not measured.

Make sure you don't leave gaps in your diagram where gas could escape

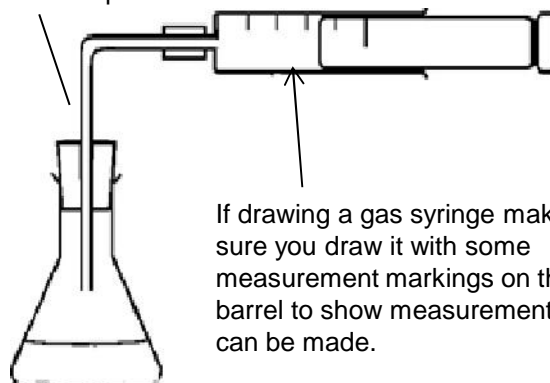

If drawing a gas syringe make sure you draw it with some measurement markings on the barrel to show measurements can be made.



## Changing the Conditions of a gas

Questions may involve the same amount of gas under different conditions.

### Example 19

40 cm<sup>3</sup> of oxygen and 60 cm<sup>3</sup> of carbon dioxide, each at 298 K and 100 kPa, were placed into an evacuated flask of volume 0.50 dm<sup>3</sup>. What is the pressure of the gas mixture in the flask at 298 K?

There are two approaches to solving this

1. Work out moles of gas using ideal gas equation then put back into ideal gas equation with new conditions
2. Or combine the equation  $n = PV/RT$  as on right

$$\frac{P_1 V_1}{T_1} = \frac{P_2 V_2}{T_2}$$

Can do this as moles of gas do not change

As Temperature is the same can make the above equation  $P_1 V_1 = P_2 V_2$

$$\begin{aligned} P_2 &= P_1 V_1 / V_2 \\ &= 100000 \times 1 \times 10^{-4} / 5 \times 10^{-4} \\ &= 20\,000 \text{ Pa} \end{aligned}$$

## Reacting Volumes of Gas

Equal volumes of any gases measured under the same conditions of temperature and pressure contain equal numbers of molecules (or atoms if the gas is monatomic)

1 mole of any gas at room pressure (1 atm) and room temperature 25°C will have the volume of 24 dm<sup>3</sup>

Volumes of gases reacting in a balanced equation can be calculated by simple ratio

**Example 20** If one burnt 500 cm<sup>3</sup> of methane at 1 atm and 300K what volume of Oxygen would be needed and what volume of CO<sub>2</sub> would be given off under the same conditions?

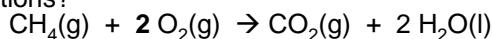

1 mole      2 mole      1 mole

500 cm<sup>3</sup>    1 dm<sup>3</sup>      500 cm<sup>3</sup>

  
Simply multiply  
gas volume x2

**Example 21** An important reaction which occurs in the catalytic converter of a car is

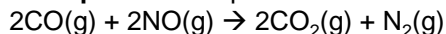

In this reaction, when 500 cm<sup>3</sup> of CO reacts with 500 cm<sup>3</sup> of NO at 650 °C and at 1 atm.

Calculate the **total** volume of gases produced at the same temperature and pressure ?



## Converting quantities between different substances using a balanced equation

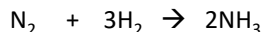

The balancing (stoichiometric) numbers are mole ratios  
e.g. 1 mole of  $\text{N}_2$  reacts with 3 moles of  $\text{H}_2$  to produce 2 moles of  $\text{NH}_3$

Typically we are given a quantity of one substance and are asked to work out a quantity for another substance in the reaction. Any of the above three equations can be used.

### 1. For pure solids, liquids and gases

$$\text{moles} = \frac{\text{mass}}{\text{Mr}}$$

### 2. For gases

$$PV = nRT$$

### 3. For solutions

$$\text{Concentration} = \frac{\text{moles}}{\text{volume}}$$

#### Step 1:

Use one of the above 3 equations to convert any given quantity into moles  
Mass  $\rightarrow$  moles  
PVT of gas  $\rightarrow$  moles  
Conc and vol of solution  $\rightarrow$  moles

#### Step 2:

Use balanced equation to convert moles of initial substance into moles of second substance

#### Step 3

Convert moles of second substance into quantity question asked for using relevant equation  
e.g. Moles, Mr  $\rightarrow$  mass  
Mole, P, T gas  $\rightarrow$  vol gas  
Moles, vol solution  $\rightarrow$  conc

**Example 22:** What mass of Carbon dioxide would be produced from heating 5.50 g of sodium hydrogencarbonate?

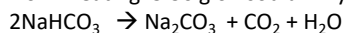

Step 1: work out moles of sodium hydrogencarbonate

$$\begin{aligned}\text{Moles} &= \text{mass} / \text{Mr} \\ &= 5.50 / 84 \\ &= 0.0655 \text{ mol}\end{aligned}$$

Step 2: use balanced equation to give moles of  $\text{CO}_2$

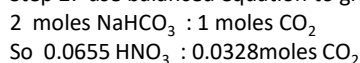

Step 3: work out mass of  $\text{CO}_2$

$$\begin{aligned}\text{Mass} &= \text{moles} \times \text{Mr} \\ &= 0.0328 \times 44.0 \\ &= 1.44 \text{ g}\end{aligned}$$

**Example 23:** 23.6  $\text{cm}^3$  of  $\text{H}_2\text{SO}_4$  neutralised 25.0  $\text{cm}^3$  of 0.150M NaOH. What is the concentration of the  $\text{H}_2\text{SO}_4$ ?

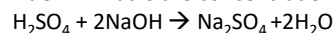

Step 1: work out moles of sodium hydroxide

$$\begin{aligned}\text{Moles} &= \text{conc} \times \text{vol} \\ &= 0.150 \times 0.025 \\ &= 0.00375 \text{ mol}\end{aligned}$$

Step 2: use balanced equation to give moles of  $\text{H}_2\text{SO}_4$

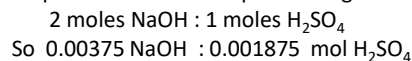

Step 3 work out concentration of  $\text{H}_2\text{SO}_4$

$$\begin{aligned}\text{conc} &= \text{moles} / \text{Volume} \\ &= 0.001875 / 0.0236 \\ &= 0.0794 \text{ mol dm}^{-3}\end{aligned}$$

**Example 24:** What is the total volume of gas produced in  $\text{dm}^3$  at 333K and 100kPa when 0.651 g of magnesium nitrate decomposes when heated?



Step 1: work out moles of magnesium nitrate

$$\begin{aligned}\text{Moles} &= \text{mass} / \text{Mr} \\ &= 0.651 / 148.3 \\ &= 0.00439 \text{ mol}\end{aligned}$$

Step 2: use balanced equation to give moles of gas produced

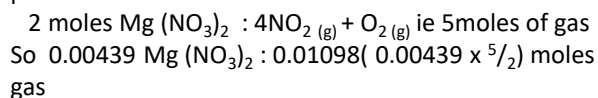

Step 3: work out volume of gas

$$\begin{aligned}\text{Volume} &= nRT/P \\ &= (0.01098 \times 8.31 \times 333) / 100000 \\ &= 0.000304 \text{ m}^3 \\ &= 0.303 \text{ dm}^3\end{aligned}$$

**Example 25:** What mass of Copper would react completely with 150  $\text{cm}^3$  of 1.60M nitric acid?

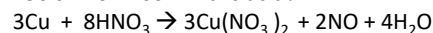

Step 1: work out moles of nitric acid

$$\begin{aligned}\text{Moles} &= \text{conc} \times \text{vol} \\ &= 1.6 \times 0.15 \\ &= 0.24 \text{ mol}\end{aligned}$$

Step 2: use balanced equation to give moles of Cu

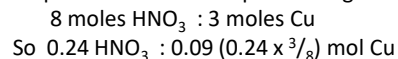

Step 3: work out mass of Cu

$$\begin{aligned}\text{Mass} &= \text{moles} \times \text{Mr} \\ &= 0.09 \times 63.5 \\ &= 5.71 \text{ g}\end{aligned}$$

## Limiting and excess reactants

**Example 26** What is the maximum mass of Titanium that could be produced from reacting 100 g of  $\text{TiCl}_4$  with 80 g of sodium

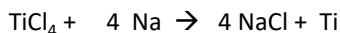

Step 1: work out amount, in mol,  $\text{TiCl}_4$   
amount = mass / Mr  
= 100 / 189.9  
= 0.527 mol

Step 1: work out amount, in mol, Na  
amount = mass / Mr  
= 80 / 23.0  
= 3.48 mol

Step 2 use balanced equation to work out which reactant is in excess  
Using  $1\text{TiCl}_4 : 4 \text{Na}$  ratio we can see that 0.527mol of  $\text{TiCl}_4$  should react with 2.108 mol of Na. We actually have 3.48 mole of Na which is an excess of 1.372 moles. We can complete calculation using the limiting reactant of  $\text{TiCl}_4$

Step 3: use balanced equation to work out amount in mol of Ti formed  
 $1 \text{ mol TiCl}_4 : 1 \text{ mole Ti}$   
So 0.527mol  $\text{TiCl}_4$  produces 0.527 mole Ti

Step 4: work out mass of Ti formed  
Mass = amount x Mr  
= 0.527 x 47.9  
= 25.24g

## % Yield and % Atom economy

$$\text{percentage yield} = \frac{\text{actual yield}}{\text{theoretical yield}} \times 100$$

$$\text{percentage atom economy} = \frac{\text{Mass of useful products}}{\text{Mass of all reactants}} \times 100$$

**Example 27:** What is the % atom economy for the following reaction where Fe is the desired product assuming the reaction goes to completion?

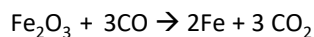

$$\begin{aligned} \text{\% atom economy} &= \frac{(2 \times 55.8)}{(2 \times 55.8 + 3 \times 16) + 3 \times (12 + 16)} \times 100 \\ &= 45.8\% \end{aligned}$$

Do take into account balancing numbers when working out % atom economy.

**Example 28:** 25.0g of  $\text{Fe}_2\text{O}_3$  was reacted and it produced 10.0g of Fe. What is the percentage yield?

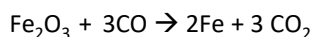

First calculate maximum mass of Fe that could be produced

Step 1: work out moles of Iron oxide  
Moles = mass / Mr  
= 25.0 / 159.6  
= 0.1566 mol

Step 2: use balanced equation to give moles of Fe  
 $1 \text{ moles Fe}_2\text{O}_3 : 2 \text{ moles Fe}$   
So  $0.1566 \text{ Fe}_2\text{O}_3 : 0.313 \text{ moles Fe}$

Step 3: work out mass of Fe  
Mass = moles x Mr  
= 0.313 x 55.8  
= 17.5g

$$\begin{aligned} \text{\% yield} &= (\text{actual yield} / \text{theoretical yield}) \times 100 \\ &= (10 / 17.5) \times 100 \\ &= 57.1\% \end{aligned}$$

## Titration

The method for carrying out the titration

- rinse equipment** (burette with acid, pipette with alkali, conical flask with distilled water)
- pipette 25 cm<sup>3</sup> of alkali into conical flask**
- touch surface of alkali with pipette** ( to ensure correct amount is added)
- adds acid solution from burette**
- make sure the jet space** in the burette is **filled** with acid
- add a few drops of indicator** and refer to colour change at end point
- phenolphthalein [pink (alkali) to colourless (acid): end point pink colour just disappears] [use if NaOH is used]
- methyl orange [yellow (alkali) to red (acid): end point orange] [use if HCl is used]
- use a white tile underneath the flask to help observe the colour change
- add acid to alkali whilst **swirling the mixture** and **add acid dropwise at end point**
- note burette reading** before and after addition of acid
- repeats titration until at least 2 concordant results** are obtained- two readings within 0.1 of each other

### Working out average titre results

Only make an average of the concordant titre results

If **2 or 3 values are within 0.10cm<sup>3</sup>** and therefore **concordant** or close then we can say results are accurate and **repeatable** and **the titration technique is good/ consistent**

### Recording results

- Results should be clearly recorded in a table
- Result should be recorded in full (i.e. both initial and final readings)
- Record titre volumes to 2dp (0.05 cm<sup>3</sup>)**

### Common Titration Equations

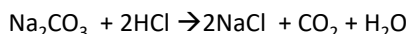
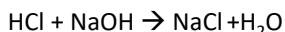
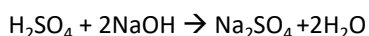

### Titration mixtures

If titrating a mixture to work out the concentration of an active ingredient it is necessary to consider if the mixture contains other substances that have acid base properties. If they don't have acid base properties we can titrate with confidence.

### Testing batches

In quality control it will be necessary to do titrations/testing on several samples as the amount/concentration of the chemical being tested may vary between samples.

### Safely dealing with excess acid

Sodium hydrogen carbonate (NaHCO<sub>3</sub>) and calcium carbonate (CaCO<sub>3</sub>) are good for neutralising excess acid in the stomach or acid spills because they are not corrosive and will not cause a hazard if used in excess. They also have no toxicity if used for indigestion remedies but the CO<sub>2</sub> produced can cause wind.

Magnesium hydroxide is also suitable for dealing with excess stomach acid as it has low solubility in water and is only weakly alkaline so not corrosive or dangerous to drink (unlike the strong alkali sodium hydroxide). It will also not produce any carbon dioxide gas.

### Safety precautions

**Acids and alkalis are corrosive (at low concentrations acids are irritants)**

**Wear eye protection and gloves**

If spilled immediately wash affected parts after spillage

If substance is unknown treat it as potentially toxic and wear gloves.

If the jet space is not filled properly prior to commencing the titration it will lead to errors if it then fills during the titration, leading to a larger than expected titre reading.

A conical flask is used in preference to a beaker because it is easier to swirl the mixture in a conical flask without spilling the contents.

Indicators are generally weak acids so we only add a few drops of them. If too much is added it will affect the titration result

Distilled water can be added to the conical flask during a titration to wash the sides of the flask so that all the acid on the side is washed into the reaction mixture to react with the alkali. It does not affect the titration reading as water does not react with the reagents or change the number of moles of acid added.

## More complicated titration calculations- taking samples

**Example 29:** A 25.0cm<sup>3</sup> sample of vinegar was diluted in a 250cm<sup>3</sup> volumetric flask. This was then put in a burette and 23.10cm<sup>3</sup> of the diluted vinegar neutralised 25.0 cm<sup>3</sup> of 0.100 M NaOH. What is the concentration of the vinegar in gdm<sup>-3</sup> ?

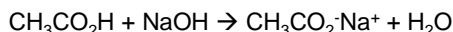

Step 1: work out moles of sodium hydroxide

$$\begin{aligned} \text{moles} &= \text{conc} \times \text{vol} \\ &= 0.10 \times 0.025 \\ &= 0.00250 \text{ mol} \end{aligned}$$

Step 2: use balanced equation to give moles of CH<sub>3</sub>CO<sub>2</sub>H

$$\begin{aligned} 1 \text{ moles NaOH} &: 1 \text{ moles CH}_3\text{CO}_2\text{H} \\ \text{So } 0.00250 \text{ NaOH} &: 0.00250 \text{ moles CH}_3\text{CO}_2\text{H} \end{aligned}$$

Step 3 work out concentration of diluted CH<sub>3</sub>CO<sub>2</sub>H in 23.1 (and 250 cm<sup>3</sup>) in mol dm<sup>-3</sup>

$$\begin{aligned} \text{conc} &= \text{moles/Volume} \\ &= 0.00250 / 0.0231 \\ &= 0.108 \text{ mol dm}^{-3} \end{aligned}$$

Step 4 work out concentration of original concentrated CH<sub>3</sub>CO<sub>2</sub>H in 25cm<sup>3</sup> in mol dm<sup>-3</sup>

$$\text{conc} = 0.108 \times 10 = 1.08 \text{ mol dm}^{-3}$$

Step 5 work out concentration of CH<sub>3</sub>CO<sub>2</sub>H in original concentrated 25 cm<sup>3</sup> in gdm<sup>-3</sup>

$$\begin{aligned} \text{conc in gdm}^{-3} &= \text{conc in mol dm}^{-3} \times \text{Mr} \\ &= 1.08 \times 60 = 64.8 \text{ g dm}^{-3} \end{aligned}$$

**Example 30.** An unknown metal carbonate reacts with hydrochloric acid according to the following equation.  
 $\text{M}_2\text{CO}_3(\text{aq}) + 2\text{HCl}(\text{aq}) \rightarrow 2\text{MCl}(\text{aq}) + \text{CO}_2(\text{g}) + \text{H}_2\text{O}(\text{l})$   
 A 3.96 g sample of M<sub>2</sub>CO<sub>3</sub> was dissolved in distilled water to make 250 cm<sup>3</sup> of solution. A 25.0 cm<sup>3</sup> portion of this solution required 32.8 cm<sup>3</sup> of 0.175 mol dm<sup>-3</sup> hydrochloric acid for complete reaction. Calculate the Mr of M<sub>2</sub>CO<sub>3</sub> and identify the metal M

1. Calculate the number of moles of HCl used

$$\begin{aligned} \text{moles} &= \text{conc} \times \text{vol} \\ &= 0.175 \times 0.0328 \\ &= 0.00574 \text{ mol} \end{aligned}$$

2. Work out number of moles of M<sub>2</sub>CO<sub>3</sub> in 25.0 cm<sup>3</sup> put in conical flask

$$\begin{aligned} &\text{use balanced equation to give moles of M}_2\text{CO}_3 \\ &2 \text{ mol HCl} : 1 \text{ mol M}_2\text{CO}_3 \\ \text{So } 0.00574 \text{ NaOH} &: 0.00287 \text{ moles M}_2\text{CO}_3 \end{aligned}$$

3. Calculate the number of moles M<sub>2</sub>CO<sub>3</sub> acid in original 250 cm<sup>3</sup> of solution

$$\begin{aligned} \text{Moles in } 250\text{cm}^3 &= 0.00287 \times 10 \\ &= 0.0287 \end{aligned}$$

4. work out the Mr of M<sub>2</sub>CO<sub>3</sub>

$$\begin{aligned} \text{Mr} &= \text{mass} / \text{moles} \\ &= 3.96 / 0.0287 = 138.0 \end{aligned}$$

5. Work out Ar of M =  $\frac{138-12-16 \times 3}{2}$

$$\text{Ar of M} = 39 \quad \text{M} = \text{potassium}$$

## Common Titration Equations

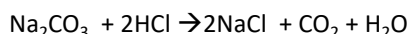
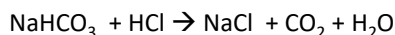
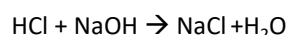
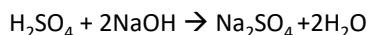
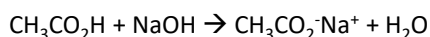

## Example 31

950 mg of impure calcium carbonate tablet was crushed. 50.0 cm<sup>3</sup> of 1.00 mol dm<sup>-3</sup> hydrochloric acid, an excess, was then added. After the tablet had reacted, the mixture was transferred to a volumetric flask. The volume was made up to exactly 100 cm<sup>3</sup> with distilled water. 10.0 cm<sup>3</sup> of this solution was titrated with 11.1cm<sup>3</sup> of 0.300 mol dm<sup>-3</sup> sodium hydroxide solution.

What is the percentage of CaCO<sub>3</sub> by mass in the tablet?

1. Calculate the number of moles of sodium hydroxide used

$$\begin{aligned} \text{moles} &= \text{conc} \times \text{vol} \\ &= 0.30 \times 0.0111 \\ &= 0.00333 \text{ mol} \end{aligned}$$

2. Work out number of moles of hydrochloric acid left in 10.0 cm<sup>3</sup>

use balanced equation to give moles of HCl

$$\begin{aligned} 1 \text{ mol NaOH} &: 1 \text{ mol HCl} \\ \text{So } 0.00333 \text{ NaOH} &: 0.00333 \text{ moles HCl} \end{aligned}$$

3. Calculate the number of moles of hydrochloric acid left in 100 cm<sup>3</sup> of solution

$$\begin{aligned} \text{Moles in } 100\text{cm}^3 &= 0.00333 \times 10 \\ &= 0.0333 \end{aligned}$$

4. Calculate the number of moles of HCl that reacted with the indigestion tablet.

In original HCl 50.0 cm<sup>3</sup> of 1.00 mol dm<sup>-3</sup> there is 0.05 moles

$$\begin{aligned} \text{moles of HCl that} &= 0.05 - 0.0333 \\ \text{reacted with the} &= 0.0167 \\ \text{indigestion tablet.} & \end{aligned}$$

5 Use balanced equation to give moles of CaCO<sub>3</sub>

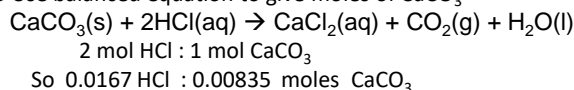

6. work out the mass of CaCO<sub>3</sub> in original tablet

$$\begin{aligned} \text{mass} &= \text{moles} \times \text{Mr} \\ &= 0.00835 \times 100 = 0.835 \text{ g} \end{aligned}$$

$$\begin{aligned} \text{percentage of} & \\ \text{CaCO}_3 \text{ by mass in} &= 0.835 / 0.950 \quad \times 100 \\ \text{the tablet} &= 87.9\% \end{aligned}$$

# Uncertainty

## Readings and Measurements

### Readings

the values found from a single judgement when using a piece of equipment

### Measurements

the values taken as the difference between the judgements of two values (e.g. using a burette in a titration)

The uncertainty of a reading (one judgement) is at least  $\pm 0.5$  of the smallest scale reading.  
The uncertainty of a measurement (two judgements) is at least  $\pm 1$  of the smallest scale reading.

### Calculating Apparatus Uncertainties

Each type of apparatus has a sensitivity uncertainty

- balance  $\pm 0.001$  g
- volumetric flask  $\pm 0.1$  cm<sup>3</sup>
- 25 cm<sup>3</sup> pipette  $\pm 0.1$  cm<sup>3</sup>
- burette (start & end readings and end point)  $\pm 0.15$  cm<sup>3</sup>

Calculate the percentage error for each piece of equipment used by

$$\% \text{ uncertainty} = \pm \frac{\text{uncertainty}}{\text{Measurement made on apparatus}} \times 100$$

e.g. for burette

$$\% \text{ uncertainty} = 0.15 / \text{average titre result} \times 100$$

To calculate the maximum total percentage apparatus uncertainty in the final result add all the individual equipment uncertainties together.

To decrease the apparatus uncertainties you can either decrease the sensitivity uncertainty by using apparatus with a greater resolution (finer scale divisions) or you can increase the size of the measurement made.

### Uncertainty of a measurement using a burette.

If the burette used in the titration had an uncertainty for each reading of  $\pm 0.05$  cm<sup>3</sup> then during a titration two readings would be taken so the uncertainty on the titre volume would be  $\pm 0.10$  cm<sup>3</sup>. Then often another 0.05 is added on because of uncertainty identifying the end point colour change

### Reducing uncertainties in a titration

Replacing measuring cylinders with pipettes or burettes which have lower apparatus uncertainty will lower the error

To reduce the uncertainty in a burette reading it is necessary to make the titre a larger volume. This could be done by: increasing the volume and concentration of the substance in the conical flask or by decreasing the concentration of the substance in the burette.

If looking at a series of measurements in an investigation the experiments with the smallest readings will have the highest experimental uncertainties.

### Reducing uncertainties in measuring mass

Using a more accurate balance or a larger mass will reduce the uncertainty in weighing a solid  
Weighing sample before and after addition and then calculating difference will ensure a more accurate measurement of the mass added.

### Calculating the percentage difference between the actual value and the calculated value

If we calculated an Mr of 203 and the real value is 214, then the calculation is as follows:  
Calculate difference  $214 - 203 = 11$   
 $\% = 11 / 214 \times 100$   
 $= 5.41\%$

If the %uncertainty due to the apparatus  $<$  percentage difference between the actual value and the calculated value then there is a discrepancy in the result due to other errors.

If the %uncertainty due to the apparatus  $>$  percentage difference between the actual value and the calculated value then there is no discrepancy and all errors in the results can be explained by the sensitivity of the equipment.