

1.8 Thermodynamics

Definitions of enthalpy changes

Enthalpy change of formation

The standard enthalpy change of formation of a compound is the energy transferred when **1 mole of the compound** is formed from its **elements** under **standard conditions (298K and 100kpa)**, all reactants and products being in their standard states

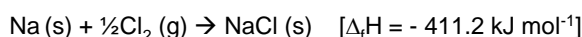

Enthalpy of atomisation

The enthalpy of atomisation of an element is the enthalpy change when 1 mole of gaseous atoms is formed from the element in its standard state

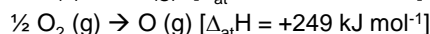

The enthalpy change for a solid metal turning to gaseous atoms can also be called the **Enthalpy of sublimation** and will numerically be the same as the enthalpy of atomisation



Bond dissociation enthalpy (bond energy)

The bond dissociation enthalpy is the standard molar enthalpy change when one mole of a covalent bond is broken into two gaseous atoms (or free radicals)



Or

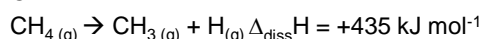

For diatomic molecules the $\Delta_{\text{diss}} H$ of the molecule is the same as $2 \times \Delta_{\text{at}} H$ of the element

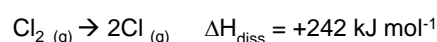

First Ionisation enthalpy

The first ionisation enthalpy is the enthalpy change required to remove 1 mole of electrons from 1 mole of gaseous atoms to form 1 mole of gaseous ions with a +1 charge

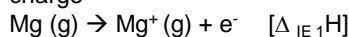

Second Ionisation enthalpy

The second ionisation enthalpy is the enthalpy change to remove 1 mole of electrons from one mole of gaseous 1+ ions to produce one mole of gaseous 2+ ions.

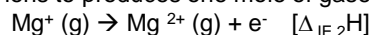

First Electron affinity

The first electron affinity is the enthalpy change that occurs when 1 mole of gaseous atoms gain 1 mole of electrons to form 1 mole of gaseous ions with a -1 charge

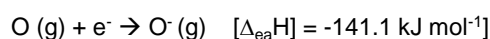

The first electron affinity is exothermic for atoms that normally form negative ions because the ion is more stable than the atom and there is an attraction between the nucleus and the electron

second electron affinity

The second electron affinity is the enthalpy change when one mole of gaseous 1- ions gains one electron per ion to produce gaseous 2- ions.

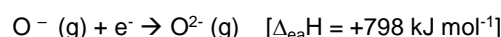

The second electron affinity for oxygen is **endothermic** because it takes energy to overcome the **repulsive force** between the **negative ion and the electron**

Enthalpy of lattice formation

The Enthalpy of lattice formation is the standard enthalpy change when **1 mole** of an ionic crystal lattice is formed from its constituent **ions in gaseous form**.

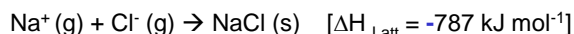

Enthalpy of lattice dissociation

The Enthalpy of lattice dissociation is the standard enthalpy change when 1 mole of an ionic crystal lattice form is separated into its constituent ions in gaseous form.

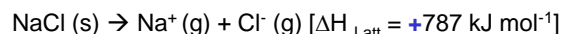

Note the conflicting definitions and the sign that always accompanies the definitions

Enthalpy of Hydration $\Delta_{\text{hyd}} H$

Enthalpy change when **one mole of gaseous ions** become **aqueous ions**.

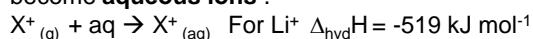

or



This always gives out energy (exothermic, -ve) because bonds are made between the ions and the water molecules

Enthalpy of solution

The enthalpy of solution is the standard enthalpy change when one mole of an ionic solid dissolves in a large enough amount of water to ensure that the dissolved ions are well separated and do not interact with one another

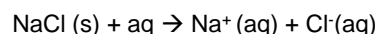

BORN HABER CYCLES

The lattice enthalpy cannot be determined directly. We calculate it indirectly by making use of changes for which data are available and link them together in an enthalpy cycle the Born Haber cycle

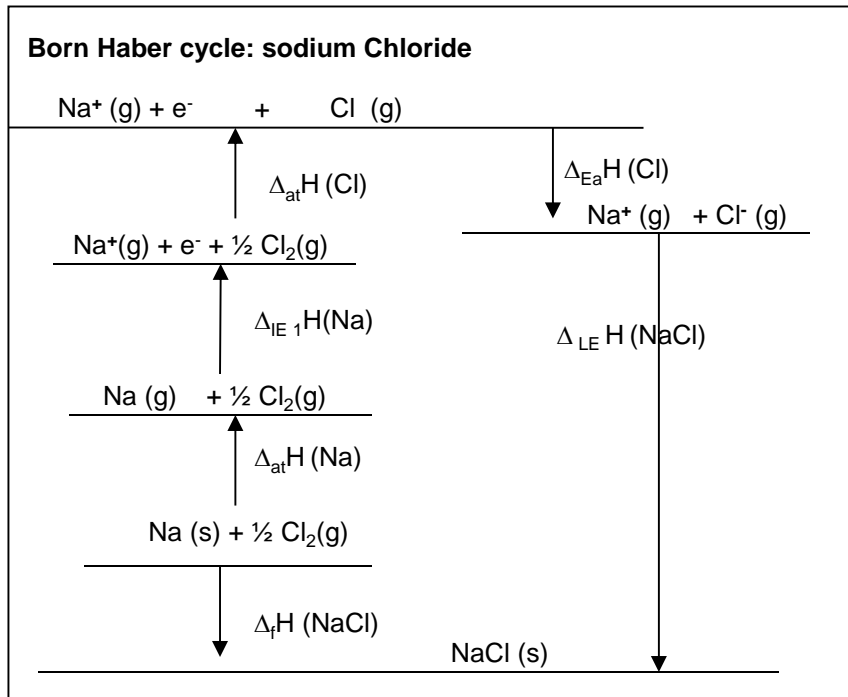

Pay attention to state symbols and direction of arrows.

Usually all pieces of data are given except the one that needs to be calculated

Careful

This Born Haber cycle has been constructed using a lattice enthalpy of formation. Sometimes questions will give the enthalpy of lattice dissociation which has the opposite sign and the arrow points in the opposite direction. This changes the calculation

By applying Hess's law the heat of formation equals to the sum of everything else

$$\Delta_f H = \Delta_{at} H(\text{Na}) + \Delta_{IE} H(\text{Na}) + \Delta_{at} H(\text{Cl}) + \Delta_{Ea} H(\text{Cl}) + \Delta_{LE} H$$

Rearrange to give $\Delta_{LE} H = \Delta_f H - (\Delta_{at} H(\text{Na}) + \Delta_{IE} H(\text{Na}) + \Delta_{at} H(\text{Cl}) + \Delta_{Ea} H(\text{Cl}))$

$$\Delta_{LE} H = -411 - (+107 + 496 + 122 + -349) = -787 \text{ kJmol}^{-1}$$

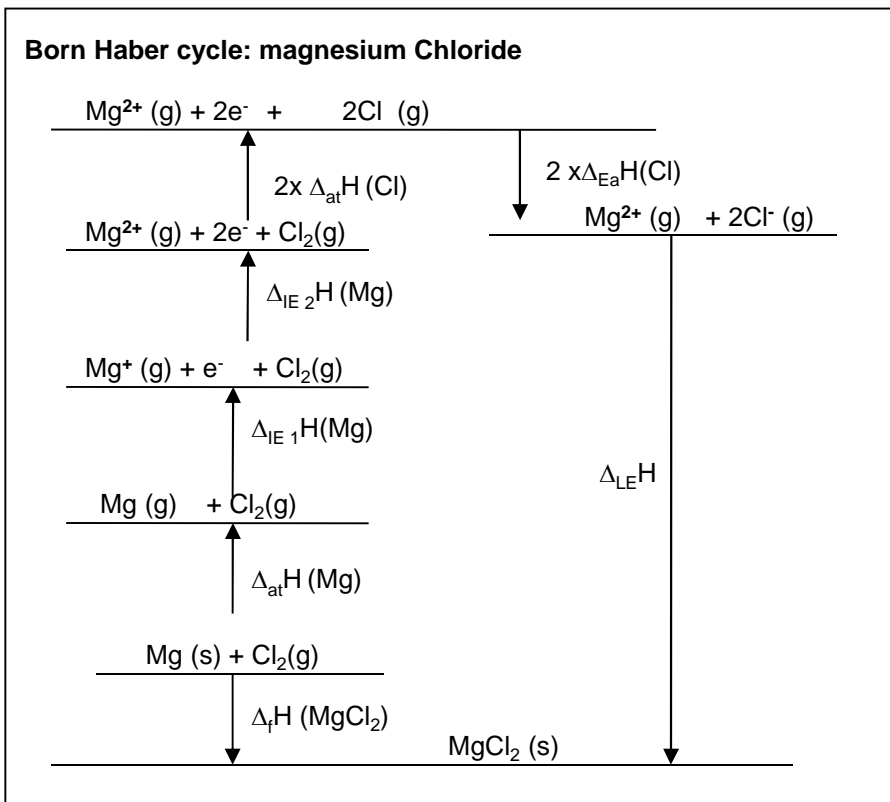

The data for the $\Delta_{at} H(\text{Cl})$ could also be given as the bond energy for $E(\text{Cl}-\text{Cl})$ bond.

Remember :

$$E(\text{Cl}-\text{Cl}) = 2 \times \Delta_{at} H(\text{Cl})$$

Note in this example the first and second ionisation energies of magnesium are needed as Mg is a +2 ion

Born Haber cycle: calcium oxide

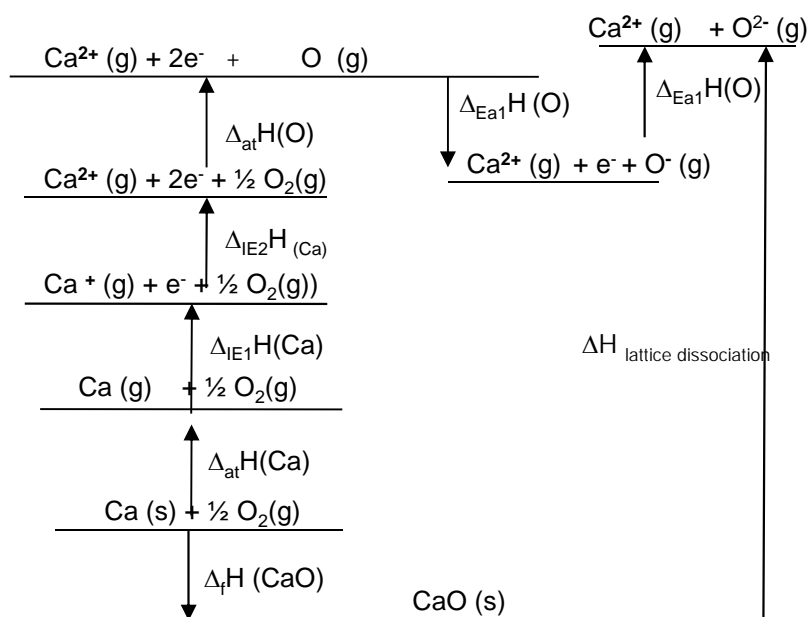

Notice the second electron affinity for oxygen is **endothermic** because it take energy to overcome the **repulsive force** between the **negative ion and the electron**

In this case the cycle has been constructed using

$\Delta H_{\text{lattice dissociation}}$
 The calculation therefore is:
 $(\Delta_f H(\text{CaO}) + \Delta H_{\text{lattice dissociation}}) =$
 $(\Delta_{\text{at}} H(\text{Ca}) + \Delta_{\text{IE}1} H(\text{Ca}) + \Delta_{\text{IE}2} H(\text{Ca}) +$
 $\Delta_{\text{at}} H(\text{O}) + \Delta_{\text{Ea}1} H(\text{O}) + \Delta_{\text{Ea}2} H(\text{O}))$

Trends in Lattice Enthalpies

The strength of a enthalpy of lattice formation depends on the following factors

1. The sizes of the ions:

The larger the ions, the less negative the enthalpies of lattice formation (i.e. a weaker lattice). As the ions are larger the charges become further apart and so have a weaker attractive force between them.

2. The charges on the ion:

The bigger the charge of the ion, the greater the attraction between the ions so the stronger the lattice enthalpy (more negative values).

The lattice enthalpies become less negative down any group.
 e.g. LiCl, NaCl, KCl, RbCl

e.g group 1 halides (eg NaF KI) have lattice enthalpies of around -700 to -1000

group 2 halides (eg MgCl_2) have lattice enthalpies of around -2000 to -3500

group 2 oxides eg MgO have lattice enthalpies of around -3000 to -4500 kJ mol^{-1}

Perfect Ionic Model

Theoretical lattice enthalpies assumes a **perfect ionic model** where the **ions are 100% ionic** and **spherical** and the **attractions are purely electrostatic**.

Differences between theoretical and Born Haber (experimental) lattice enthalpies

The Born Haber lattice enthalpy is the real experimental value. When a compound shows covalent character, the theoretical and the born Haber lattice enthalpies differ. The more the covalent character the bigger the difference between the values.

There is a tendency towards covalent character in ionic substances when

- the positive ion is small
- the positive ion has multiple charges
- the negative ion is large
- the negative ion has multiple negative charges.

When a compound has some covalent character- it tends towards giant covalent so the lattice is stronger than if it was 100% ionic. Therefore the born haber value would be larger than the theoretical value.

When the negative ion becomes distorted and more covalent we say it becomes polarised. The metal cation that causes the polarisation is called more polarising if it polarises the negative ion.

100% ionic

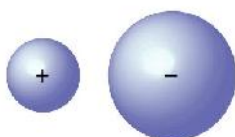

When 100 % ionic the ions are spherical. The theoretical and the born Haber lattice enthalpies will be the same

Ionic with covalent character

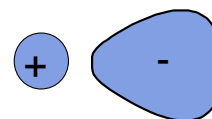

The charge cloud is distorted. The theoretical and the experimental Born Haber lattice enthalpies will differ

Why does Calcium chloride have the formula CaCl_2 and not CaCl or CaCl_3 ?

It is useful to draw out the born haber cycles for each potential case.

We need to calculate an enthalpy of formation for each case.

The one with the **most exothermic enthalpy of formation** will be the one that forms as it will be the most thermodynamically stable

Theoretical lattice enthalpies have been calculated for each case

Theoretical lattice enthalpies
 $\Delta H_{\text{latt}} \text{CaCl} = -719 \text{ kJ mol}^{-1}$
 $\Delta H_{\text{latt}} \text{CaCl}_2 = -2218 \text{ kJ mol}^{-1}$
 $\Delta H_{\text{latt}} \text{CaCl}_3 = -4650 \text{ kJ mol}^{-1}$

These get larger as the positive charge on the calcium ion becomes bigger.

The enthalpy of formation is largely a balance of the ionisation energy and lattice enthalpy.

$\Delta H_f (\text{CaCl})$ is $-163.1 \text{ kJ mol}^{-1}$. This is exothermic.

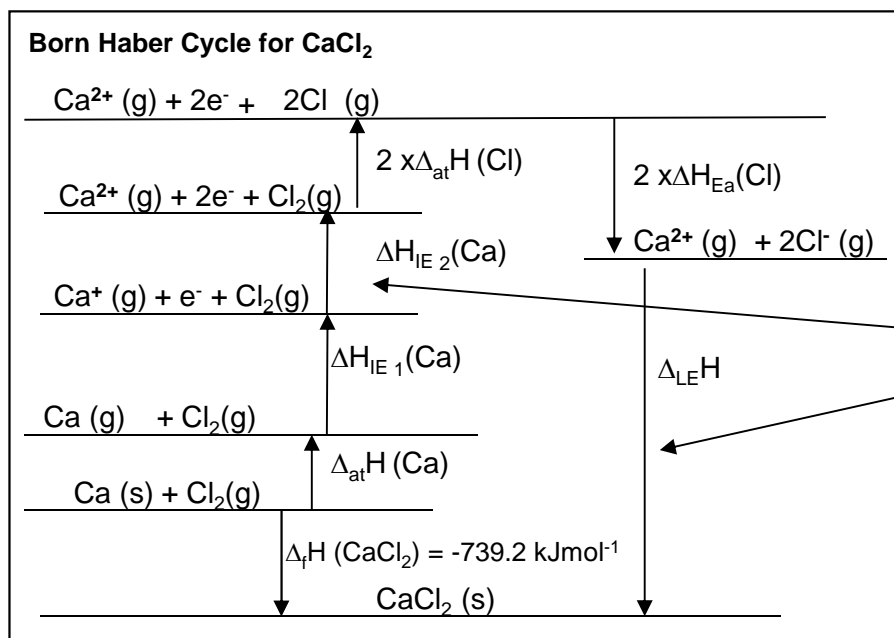
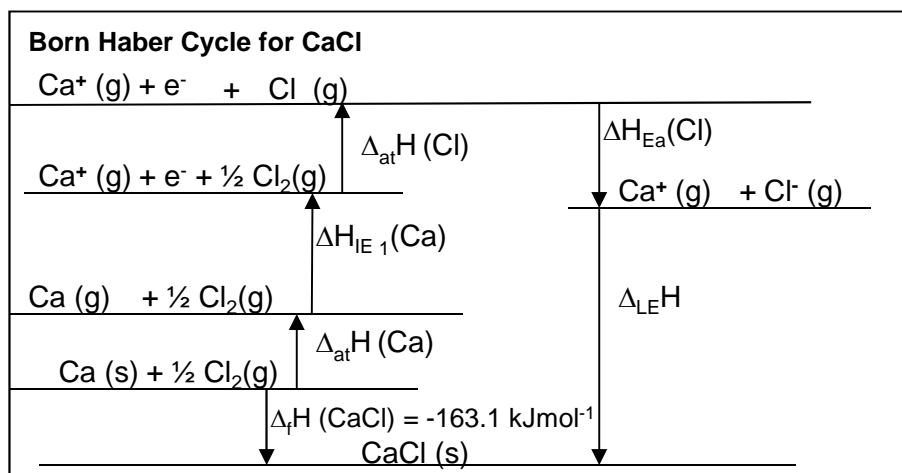

The increased ionisation enthalpy to form Ca^{2+} is more than compensated for by the stronger lattice enthalpy of formation

The enthalpy of formation is therefore more exothermic. This is the most stable form

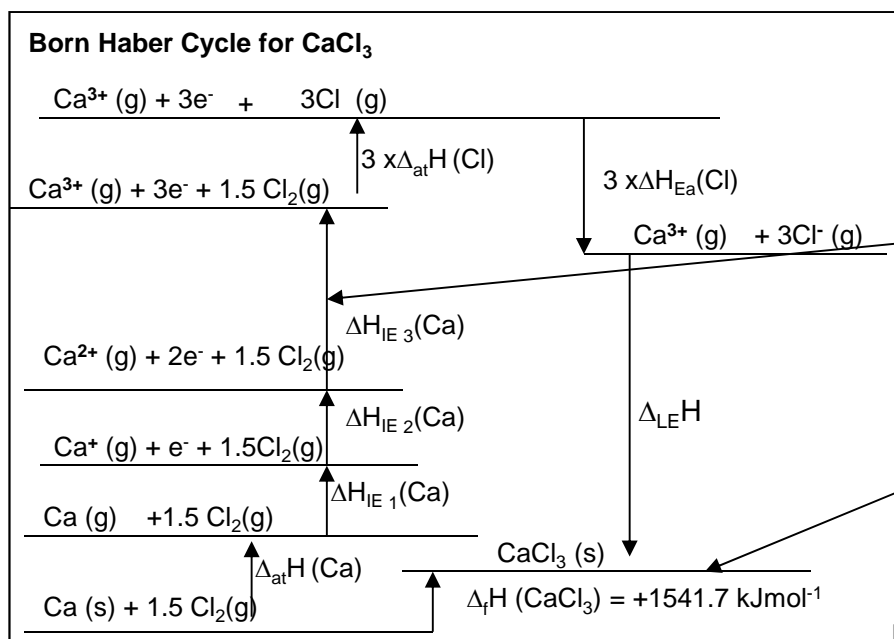

The big increase in ionisation enthalpy to remove the 3rd electron is not compensated for by the stronger lattice enthalpy of formation

The enthalpy of formation is therefore endothermic. This is the least stable form

Free-energy change (ΔG) and entropy change (ΔS)

A **SPONTANEOUS PROCESS** (e.g. diffusion) will proceed on its own without any external influence.

A problem with ΔH

A reaction that is exothermic will result in products that are more **thermodynamically stable** than the reactants. This is a driving force behind many reactions and causes them to be **spontaneous** (occur without any external influence).

Some spontaneous reactions, however, are endothermic.

How can this be explained?

We need to consider something called **entropy**

Entropy, S°

Substances with more ways of arranging their atoms and energy (*more disordered*) have a higher entropy.

Elements	...tend to have lower entropies than...	Compounds
Simpler compounds		Complex compounds
Pure substances		Mixtures

Solids have lower entropies than liquids which are lower than gases. When a solid increases in Temperature its entropy increases as the particles vibrate more.

There is a bigger jump in entropy with boiling than that with melting.

Gases have large entropies as they are much more disordered

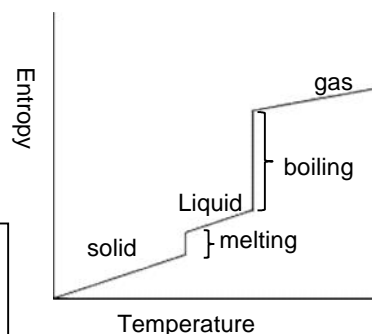

At 0K substances have zero entropy. There is no disorder as particles are stationary

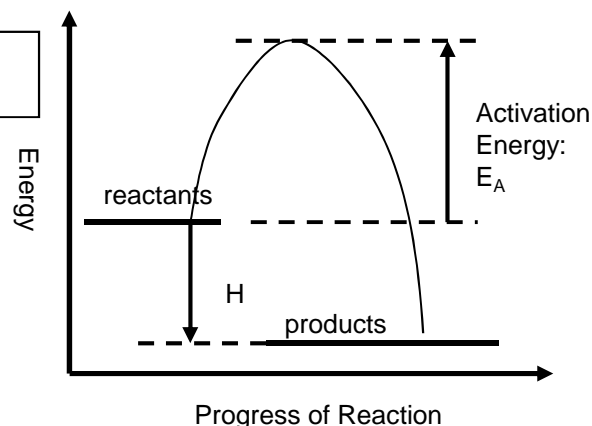

Predicting Change in entropy ' ΔS° ' Qualitatively

An **increase** in disorder and **entropy** will lead to a positive entropy change $\Delta S^\circ = +ve$

Balanced chemical equations can often be used to predict if ΔS° is positive or negative.

In general, a significant increase in the entropy will occur if:
 - there is a **change of state** from **solid or liquid to gas**
 - there is a significant **increase in number of molecules** between products and reactants.

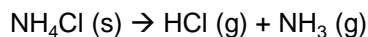

$\Delta S^\circ = +ve$

- change from solid reactant to gaseous products
 - increase in number of molecules
- both will increase disorder

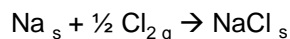

$\Delta S^\circ = -ve$

- change from gaseous and solid reactant to solid
 - decrease in number of molecules
- both will decrease disorder

Calculating ΔS° quantitatively

Data books lists standard entropies (S°) **per mole** for a variety of substances. It is not possible for a substance to have a standard entropy of less than zero.

The unit of entropy is $\text{J K}^{-1} \text{ mol}^{-1}$

$$\Delta S^\circ = S^\circ_{\text{products}} - S^\circ_{\text{reactants}}$$

Elements in their standard states do *not* have zero entropy. **Only perfect crystals at absolute zero ($T = 0 \text{ K}$) will have zero entropy:**

Example

Calculate S° for the following reaction at 25°C:

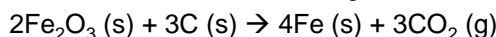

$$\begin{aligned} S^\circ &= S^\circ_{\text{products}} - S^\circ_{\text{reactants}} \\ &= (3 \times 213.6 + 4 \times 27.3) - (2 \times 87.4 + 3 \times 5.7) \\ &= +558.1 \text{ J K}^{-1} \text{ mol}^{-1} = \underline{\underline{+558 \text{ J K}^{-1} \text{ mol}^{-1}}} \text{ (3 S.F.)} \end{aligned}$$

$$S[\text{Fe}_2\text{O}_3] = 87.4 \text{ J K}^{-1} \text{ mol}^{-1}$$

$$S[\text{C}] = 5.7 \text{ J K}^{-1} \text{ mol}^{-1}$$

$$S[\text{Fe}] = 27.3 \text{ J K}^{-1} \text{ mol}^{-1}$$

$$S[\text{CO}_2] = 213.6 \text{ J K}^{-1} \text{ mol}^{-1}$$

Note: the entropy change is very positive as a large amount of gas is being created increasing disorder

Gibbs Free Energy Change, G

The balance between entropy and enthalpy determines the feasibility of a reaction.

This is given by the relationship :

$$G = H - T S$$

For any spontaneous change, G will be **negative**.

Gibbs free energy is a term that combines the effect of enthalpy and entropy into one number

A reaction that has increasing entropy (+ve S) and is exothermic (-ve H) will make G be **negative** and will always be feasible

Convert from °C to K (+ 273)

$$G = H - T S$$

Units: KJ mol^{-1} Units: KJ mol^{-1} Unit of $S = \text{J K}^{-1} \text{ mol}^{-1}$
Need to convert to $\text{KJ K}^{-1} \text{ mol}^{-1}$ ($\div 1000$)

If G is negative there is still a possibility, however, that the reaction will not occur or will occur so slowly that effectively it doesn't happen. If the reaction has a high activation energy the reaction will not occur.

Example : Data for the following reaction, which represents the reduction of aluminium oxide by carbon, are shown in the table.

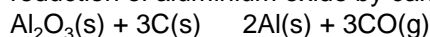

Calculate the values of H° , S° and G° for the above reaction at 298 K

1. Calculate S°

$$\begin{aligned} S^\circ &= S^\circ_{\text{products}} - S^\circ_{\text{reactants}} \\ &= (2 \times 28 + 3 \times 198) - (51 + 3 \times 6) \\ &= +581 \text{ J K}^{-1} \text{ mol}^{-1} \text{ (3 S.F.)} \end{aligned}$$

2. Calculate H°

$$\begin{aligned} H^\circ &= \sum H^\circ_{\text{products}} - \sum H^\circ_{\text{reactants}} \\ &= (3 \times -111) - (-1669) \\ &= +1336 \text{ kJ mol}^{-1} \end{aligned}$$

Substance	$\sum H^\circ / \text{kJ mol}^{-1}$	$\sum S^\circ / \text{JK}^{-1} \text{ mol}^{-1}$
$\text{Al}_2\text{O}_3(\text{s})$	-1669	51
$\text{C}(\text{s})$	0	6
$\text{Al}(\text{s})$	0	28
$\text{CO}(\text{g})$	-111	198

3. Calculate G°

$$\begin{aligned} G^\circ &= H^\circ - T S^\circ \\ &= +1336 - 298 \times 0.581 \\ &= +1163 \text{ kJ mol}^{-1} \end{aligned}$$

G° is positive. The reaction is not feasible

Calculating the temperature a reaction will become feasible

Calculate the temperature range that this reaction will be feasible

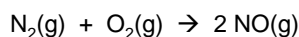

$$H = 180 \text{ kJ mol}^{-1} \quad S = 25 \text{ J K}^{-1} \text{ mol}^{-1}$$

The reaction will be feasible when $G = 0$

Make $G = 0$ in the following equation $G = H - T S$

$$0 = \Delta H - T \Delta S$$

$$\text{So } T = H / S$$

$$\begin{aligned} T &= 180 / (25/1000) \\ &= 7200 \text{ K} \end{aligned}$$

The T must be $>7200 \text{ K}$ which is a high Temp!

G during phase changes

As physical phase changes like melting and boiling are equilibria, the G for such changes is zero.

What temperature would methane melt at?



Make $G = 0$ in the following equation $G = H - T S$

$$0 = H - T S$$

$$\text{So } T = H / S$$

$$T = 0.94 / (10.3 \div 1000)$$

$$T = 91 \text{ K}$$

Effect of Temperature on feasibility

$$G = H - T S$$

Changing Temperature will change the value of $-T S$ in the above equation

If the reaction involves an increase in entropy (S is +ve) then increasing Temperature will make it more likely that **G is negative and more likely that the reaction occurs** e.g. $\text{NaCl} + \text{aq} \rightarrow \text{Na}^+_{(\text{aq})} + \text{Cl}^-_{(\text{aq})}$

If the reaction involves a decrease in entropy (S is -ve) then increasing Temperature will make it more **less likely** that **G is negative and less likely for the reaction to occur**. E.g. $\text{HCl}(\text{g}) + \text{NH}_3(\text{g}) \rightarrow \text{NH}_4\text{Cl}(\text{s})$

If the reaction has a **S close to zero** then temperature will not have a large effect on the feasibility of the reaction as $-T S$ will be **small** and **G won't change much** e.g. $\text{N}_2(\text{g}) + \text{O}_2(\text{g}) \rightarrow 2\text{NO}(\text{g})$

This graph shows how the free-energy change for formation of ammonia varies with temperature above 240 K.

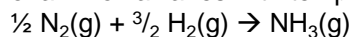

Applying the equation of a straight line

$y = mx + c$ to the $G = H - T S$ equation.

$$c = H$$

The gradient of this graph is equal to $-S$

The positive gradient means S is negative which corresponds to the equation above showing increasing order.

When $G < 0$ then the reaction is spontaneous. In this case at Temperatures below around 460K

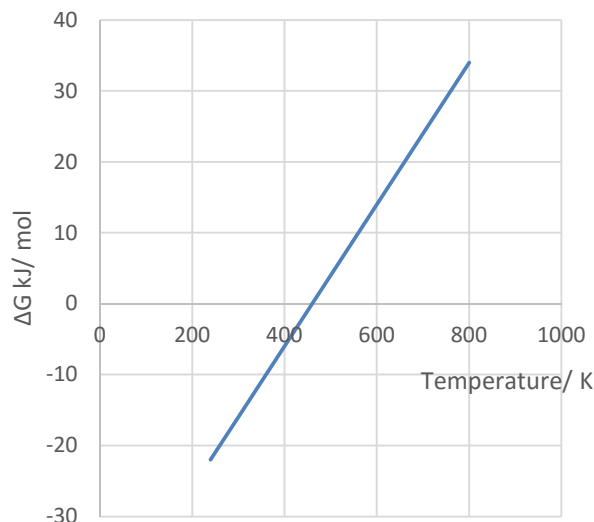

The slope of the line would change below 240K because ammonia would be a liquid and the entropy change would be different

Enthalpies of solution

Using Hess's law to determine enthalpy changes of solution

When an ionic lattice dissolves in water it involves breaking up the bonds in the lattice and forming new bonds between the metal ions and water molecules.

For MgCl_2 the ionic equation for the dissolving is $\text{MgCl}_2(\text{s}) + \text{aq} \rightarrow \text{Mg}^{2+}(\text{aq}) + 2\text{Cl}^-(\text{aq})$

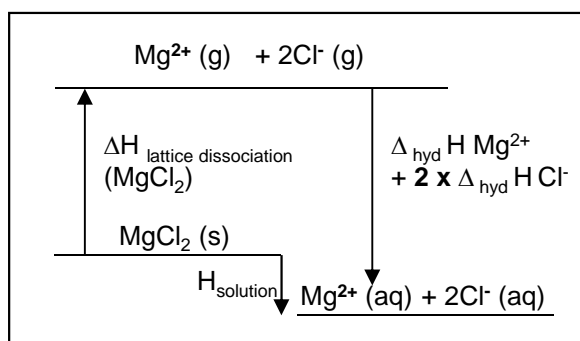

When an ionic substance dissolves the lattice must be broken up. The enthalpy of lattice dissociation is equal to the energy needed to break up the lattice (to gaseous ions). This step is **endothermic**.

The size of the lattice enthalpy depends on the size and charge on the ion. The smaller the ion and the higher its charge the stronger the lattice

In general

$$\Delta H_{\text{solution}} = \Delta H_{\text{L dissociation}} + \sum \Delta_{\text{hyd}} H$$

OR

$$\Delta H_{\text{solution}} = -\Delta H_{\text{L formation}} + \sum \Delta_{\text{hyd}} H_{\text{hyd}}$$

Sometimes in questions $\Delta H_{\text{L formation}}$ is given instead of $\Delta H_{\text{L dissociation}}$ in order to catch you out. Remember the difference between the two.

Example . Calculate the enthalpy of solution of NaCl given that the lattice enthalpy of formation of NaCl is -771 kJmol^{-1} and the enthalpies of hydration of sodium and chloride ions are -406 and -364 kJmol^{-1} respectively

$$\begin{aligned}\Delta_{\text{sol}} H &= -\Delta H_{\text{Latt formation}} + \Sigma \Delta_{\text{hyd}} H \\ &= -(-771) + (-406-364) \\ &= +1 \text{ kJmol}^{-1}\end{aligned}$$

H solution endothermic.

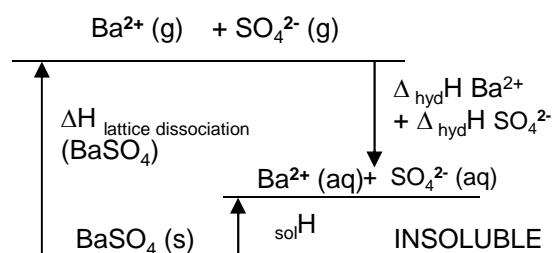

Hydration enthalpies are **exothermic** as energy is given out as water molecules bond to the metal ions.

The **negative** ions are attracted to the **+ hydrogens** on the **polar water** molecules and the positive ions are attracted to the **- oxygen** on the polar water molecules.

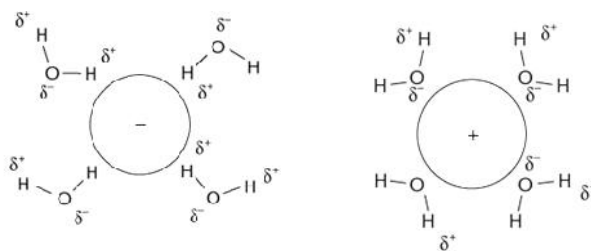

The higher the **charge density** the greater the hydration enthalpy (e.g. **smaller ions** or **ions with larger charges**) as the ions attract the water molecules more strongly.

e.g. Fluoride ions have more negative hydration enthalpies than chloride ions

Magnesium ions have a more negative hydration enthalpy than barium ions

What does H_{Solution} tell us?

Generally **H solution** is not very exo or endothermic so the hydration enthalpy is about the same as lattice enthalpy.

In general the substance is more likely to **be soluble** if the **H solution is exothermic**.

If a substance is insoluble it is often because the lattice enthalpy is much larger than the hydration enthalpy and it is not energetically favourable to break up the lattice, making **H solution endothermic**.

We must consider **entropy**, however, to give us the full picture about solubility.

When a solid dissolves into ions the **entropy increases** as there is **more disorder** as solid changes to solution and **number of particles increases**.

This positive ΔS can make ΔG negative even if ΔH solution is endothermic, especially at higher temperatures.

For salts where H solution is exothermic the salt will always dissolve at all Temperatures

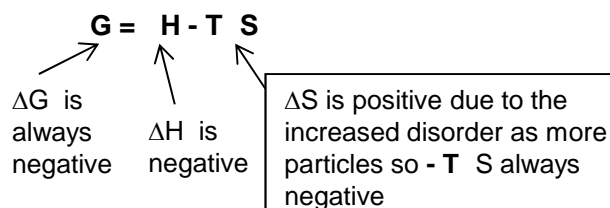

For salts where H solution is endothermic the salt may dissolve depending on whether the $-T S$ value is more negative than H is positive

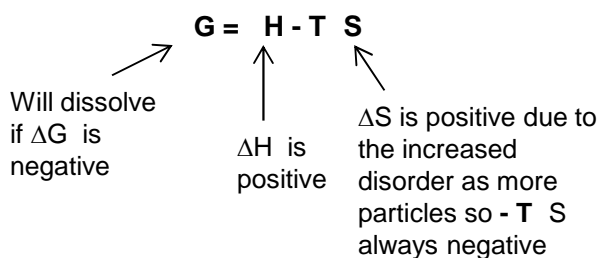

Increasing the Temperature will make it more likely that ΔG will become negative, making the reaction feasible and the salt dissolve